
Programmer's Guide

Publication number 16500-97009
Second edition, April 1994

For Safety information, Warranties, and Regulatory
information, see the pages behind the index

© Copyright Hewlett-Packard Company 1987, 1990, 1993, 1994
All Rights Reserved

HP 16500B/16501A Logic Analysis System

In This Book

This programmer's guide contains general information, mainframe level commands, and programming examples for programming the HP 16500B/16501A Logic Analysis System. This guide focuses on how to program the system over the HP-IB and the RS-232C interfaces. However, if you have the optional HP 16500L LAN Interface Module, you will need to use the *HP 16500L LAN Interface Module User's Guide* along with this guide to program the system over the LAN.

Along with the programmer's guides for the individual modules, this guide provides a complete set of programming information for your system.

Organization

When you received your HP 16500B you received two binders, Volume 1 and Volume 2. The Volume 2 binder gives you a place to insert the module programmer's guides when the Volume 1 binder is full.

As you purchase additional measurement modules, insert their programmer's guides in the back of this binder or in the second binder.

What is in the HP 16500B/16500A Programmer's Guide?

The *HP 16500B/16501A Programmer's Guide* is organized in three parts.

1	Introduction to Programming	
2	Programming Over HP-IB	
3	Programming Over RS-232C	
4	Programming and Documentation Conventions	
5	Message Communication and System Functions	
6	Status Reporting	
7	Error Messages	
8	Common Commands	
9	Mainframe Commands	
10	SYSTem Subsystem	
11	MMEMory Subsystem	
12	INTermodule Subsystem	
13	Programming Examples	
	Index	



Part 1 Part 1 consists of chapters 1 through 7 and contains general information about programming basics, HP-IB and RS-232C interface requirements, documentation conventions, status reporting, and error messages. If you are already familiar with IEEE 488.2 programming and HP-IB or RS-232C, you may want to just scan these chapters. If you are new to programming logic analyzers you should read part 1.

Chapter 1 is divided into two sections. The first section, "Talking to the Instrument," concentrates on program syntax, and the second section, "Receiving Information from the Instrument," discusses how to send queries and how to retrieve query results from the instrument.

Read either chapter 2, "Programming Over HP-IB," or chapter 3, "Programming Over RS-232C" for information concerning the physical connection between the HP 16500B/16501A Logic Analysis System and your controller.

Chapter 4, "Programming and Documentation Conventions," gives an overview of all instructions and also explains the notation conventions used in the syntax definitions and examples.

Chapter 5, "Message Communication and System Functions," provides an overview of the operation of instruments that operate in compliance with the IEEE 488.2 standard.

Chapter 6 explains status reporting and how it can be used to monitor the flow of your programs and measurement process.

Chapter 7 contains error message descriptions.

Part 2 Part 2, chapters 8 through 12, explain each command in the command set for the mainframe. These chapters are organized in subsystems with each subsystem representing a front-panel menu.

The commands explained in this part give you access to common commands, mainframe commands, system level commands, disk commands, and intermodule measurement commands. This part is designed to provide a concise description of each command.

Part 3 Part 3, chapter 13, contains program examples of actual tasks that show you how to get started in programming the HP 16500B/16501A Logic Analysis System at the mainframe level. The complexity of your programs and the tasks they accomplish are limited only by your imagination. These examples are written in HP BASIC 6.2; however, the program concepts can be used in any other popular programming language that allows communications over HP-IB, RS-232C, or the optional HP 16500L LAN Interface Module.

Part 1 General Information

1 Introduction to Programming

Introduction	1-2
Talking to the Logic Analysis System	1-3
Talking to Individual System Modules	1-4
Initialization	1-4
Instruction Syntax	1-6
Output Command	1-6
Device Address	1-7
Instructions	1-7
Instruction Terminator	1-8
Header Types	1-9
Duplicate Keywords	1-10
Query Usage	1-11
Program Header Options	1-12
Parameter Data Types	1-13
Selecting Multiple Subsystems	1-15
Receiving Information from the Logic Analysis System	1-16
Response Header Options	1-17
Response Data Formats	1-18
String Variables	1-19
Numeric Base	1-20
Numeric Variables	1-20
Definite-Length Block Response Data	1-21
Multiple Queries	1-22
System Status	1-23

2 Programming Over HP-IB

- Interface Capabilities 2-3
- Command and Data Concepts 2-3
- Talk/Listen Addressing 2-3
- HP-IB Bus Addressing 2-4
- Local, Remote, and Local Lockout 2-5
- Bus Commands 2-6

3 Programming Over RS-232C

- Interface Operation 3-3
- RS-232C Cables 3-3
- Minimum Three-Wire Interface with Software Protocol 3-4
- Extended Interface with Hardware Handshake 3-5
 - Cable Examples 3-6
- Configuring the Logic Analysis System Interface 3-9
- Interface Capabilities 3-10
- RS-232C Bus Addressing 3-11
- Lockout Command 3-12

4 Programming and Documentation Conventions

- Truncation Rule 4-3
- Infinity Representation 4-4
- Sequential and Overlapped Commands 4-4
- Response Generation 4-4
- Syntax Diagrams 4-5
- Notation Conventions and Definitions 4-5
- The Command Tree 4-6
- Tree Traversal Rules 4-8
- Command Set Organization 4-9
- Subsystems 4-10
- Program Examples 4-12

5 Message Communication and System Functions

- Protocols 5-3
- Syntax Diagrams 5-5
- Syntax Overview 5-7

6 Status Reporting

- Event Status Register 6-4
- Service Request Enable Register 6-4
- Bit Definitions 6-4
- Key Features 6-6
- Serial Poll 6-8
- Parallel Poll 6-9
- Polling HP-IB Devices 6-11
- Configuring Parallel Poll Responses 6-11
- Conducting a Parallel Poll 6-12
- Disabling Parallel Poll Responses 6-13
- HP-IB Commands 6-13

7 Error Messages

- Device Dependent Errors 7-3
- Command Errors 7-3
- Execution Errors 7-4
- Internal Errors 7-4
- Query Errors 7-5

Part 2 Commands

8 Common Commands

- *CLS (Clear Status) 8-5
- *ESE (Event Status Enable) 8-6
- *ESR (Event Status Register) 8-7
- *IDN (Identification Number) 8-9
- *IST (Individual Status) 8-9
- *OPC (Operation Complete) 8-11
- *OPT (Option Identification) 8-12

Contents

*PRE (Parallel Poll Enable Register Enable) 8-13
*RST (Reset) 8-14
*SRE (Service Request Enable) 8-15
*STB (Status Byte) 8-16
*TRG (Trigger) 8-17
*TST (Test) 8-18
*WAI (Wait) 8-19

9 Mainframe Commands

BEEPer 9-6
CAPability 9-7
CARDcage 9-8
CESE (Combined Event Status Enable) 9-10
CESR (Combined Event Status Register) 9-11
EOI (End Or Identify) 9-13
LER (LCL Event Register) 9-13
LOCKout 9-14
MENU 9-15
MESE<N> (Module Event Status Enable) 9-16
MESR<N> (Module Event Status Register) 9-18
RMODe 9-19
RTC (Real-time Clock) 9-20
SElect 9-21
SETColor 9-23
STARt 9-24
STOP 9-25
XWINDow 9-26

10 SYSTEM Subsystem

DATA 10-5
DSP (Display) 10-6
ERRor 10-7
HEADer 10-8
LONGform 10-9
PRINt 10-10
SETup 10-12

11 MMEMemory Subsystem

AUToload 11-8
CATalog 11-9
CD (Change Directory) 11-10
COPY 11-11
DOWNload 11-12
INITialize 11-14
LOAD [:CONFIg] 11-15
LOAD :IASSembler 11-16
MKDir (Make Directory) 11-17
MSI (Mass Storage Is) 11-18
PACK 11-19
PURGe 11-20
PWD (Present Working Directory) 11-21
REName 11-22
STORe [:CONFIg] 11-23
UPLoad 11-24
VOLume 11-26

12 INTermodule Subsystem

:INTermodule 12-4
DELete 12-5
HTIME 12-6
INPort 12-7
INSert 12-8
PORTEDGE 12-9
PORTLEV 12-10
SKEW<N> 12-11
TREE 12-12
TTIME 12-13

Part 3 Programming Examples

13 Programming Examples

- Transferring the Mainframe Configuration 13-3
- Checking for Intermodule Measurement Completion 13-6
- Sending Queries to the Logic Analysis System 13-7
- Getting ASCII Data with PRINT? ALL Query 13-9
- Reading the disk with the CATalog? ALL query 13-10
- Reading the Disk with the CATalog? Query 13-11
- Printing to the disk 13-12

Index

Part 1

- 1** Introduction to Programming 1-1
- 2** Programming Over HP-IB 2-1
- 3** Programming Over RS232C 3-1
- 4** Programming and Documentation Conventions 4-1
- 5** Message Communication and System Functions 5-1
- 6** Status Reporting 6-1
- 7** Error Messages 7-1

General Information



Introduction to Programming

Introduction

This chapter introduces you to the basics of remote programming and is organized in two sections. The first section, "Talking to the Logic Analysis System," concentrates on initializing the bus, program syntax and the elements of a syntax instruction. The second section, "Receiving Information from the Logic Analysis System," discusses how queries are sent and how to retrieve query results from the system.

The programming instructions explained in this book conform to IEEE Std 488.2-1987, "IEEE Standard Codes, Formats, Protocols, and Common Commands." These programming instructions provide a means of remotely controlling the HP 16500B Logic Analysis System. There are three general categories of use. You can:

- Set up the system and start measurements
- Retrieve setup information and measurement results from the measurement modules
- Send measurement data to the measurement modules

The instructions listed in this manual give you access to the functions of the mainframe. This programming reference is designed to provide a concise description of each instruction for the mainframe. Individual module instruction descriptions are in the *Programmer's Guide* for each respective module.

See Also

Refer to the *HP 16500L LAN Interface Module User's Guide* if you have the optional HP 16500L LAN Interface Module.



Talking to the Logic Analysis System

In general, computers acting as controllers communicate with the instrument by sending and receiving messages over a remote interface, such as HP-IB, RS-232C, or the optional Ethernet LAN interface module.

This guide focuses on the HP-IB and RS-232C interfaces, however, if you plan to communicate over the LAN with the optional HP 16500L LAN Interface Module, you will need to refer to the *HP 16500L LAN Interface Module User's Guide* to understand how to send the commands in this guide.

When programming the HP 16500B with the HP 16501A Expansion Frame connected, most of the remote operation of the expansion frame is transparent. The only time a programming command is affected by the presence of the expansion frame is when the number of slots is specified or returned from a query.

Instructions for programming the system will normally appear as ASCII character strings embedded inside the output statements of a "host" language available on your controller. The host language's input statements are used to read in responses from the system. For example, HP 9000 Series 300 BASIC uses the OUTPUT statement for sending commands and queries to the system. After a query is sent, the response can be read in using the ENTER statement. All programming examples in this manual are presented in HP BASIC.

Example

This BASIC statement sends a command that causes the logic analyzer's machine 1 to be a state analyzer:

```
OUTPUT XXX; ":MACHINE1:TYPE STATE" <terminator>
```

Each part of the above statement is explained in this section.

Talking to Individual System Modules

Talking to individual system modules within the HP 16500B Logic Analysis System is done by preceding the module commands with the SELECT command and the number of the slot in which the desired module is installed. The mainframe is selected in the same way as an installed module by using the SELECT 0 command

Example

To select the module in slot 3 use the following:

```
OUTPUT XXX; ":SELECT 3 "
```

See Also

Chapter 6, "Mainframe Commands" for more information on the SELECT command.

Initialization

To make sure the bus and all appropriate interfaces are in a known state, begin every program with an initialization statement. BASIC provides a CLEAR command that clears the interface buffer. If you are using HP-IB, CLEAR will also reset the parser in the logic analysis system. The parser is the program resident in the logic analysis system that reads the instructions you send to it from the controller.

After clearing the interface, you could, for example, preset the logic analyzer module to a known state by loading a predefined configuration file from the disk.

Refer to your controller manual and programming language reference manual for information on initializing the interface.



Example

This BASIC statement would load the configuration file "DEFAULT " (if it exists) into the system.

```
OUTPUT XXX;":MMEMORY:LOAD:CONFIG 'DEFAULT ' "
```

Example Program

This program demonstrates a simple HP BASIC command structure used to program the logic analysis system.

```
10 CLEAR XXX !Initialize instrument interface
20 OUTPUT XXX;":SYSTEM:HEADER ON" !Turn headers on
30 OUTPUT XXX;":SYSTEM:LONGFORM ON" !Turn longform on
40 DIM Card$[100] !Reserve memory for string variable
50 OUTPUT XXX;":CARD CAGE?" !Verify which modules are loaded
60 ENTER XXX;Card$ !Enter result in a string variable
70 PRINT Card$ !Print result of query
80 OUTPUT XXX;":MMEM:LOAD:CONFIG 'TEST E',5" !Load configuration file
!into module in slot E
90 OUTPUT XXX;":SELECT 5" !Select module in slot E
100 OUTPUT XXX;":MENU 5,3: !Select menu for module in slot E
60 OUTPUT XXX;":RMODE SINGLE" !Select run mode
70 OUTPUT XXX;":START" !Run the measurement
```

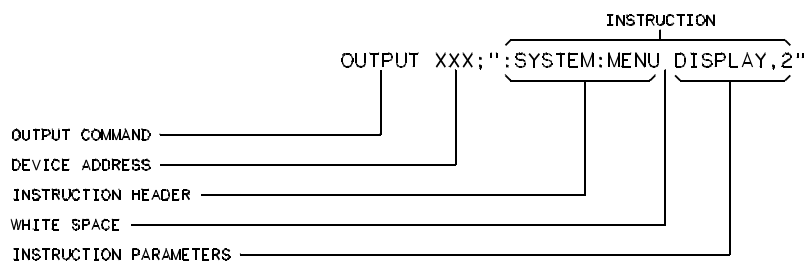
See Also

Chapter 11, "MMEMory Subsystem" for more information on the LOAD command.

Instruction Syntax

To program the system remotely, you must have an understanding of the command format and structure. The IEEE 488.2 standard governs syntax rules pertaining to how individual elements, such as headers, separators, parameters and terminators, may be grouped together to form complete instructions. Syntax definitions are also given to show how query responses will be formatted. Figure 1-1 shows the three main syntactical parts of a typical program statement: Output Command, Device Address, and Instruction. The instruction is further broken down into three parts: Instruction header, White space, and Instruction parameters.

Figure 1-1



01850530

Program Message Syntax

Output Command

The output command depends on the language you choose to use. Throughout this guide, HP 9000 Series 300 BASIC 6.2 is used in the programming examples. If you use another language, you will need to find the equivalents of BASIC Commands, like `OUTPUT`, `ENTER` and `CLEAR` in order to convert the examples. The instructions are always shown between the double quotes.



Device Address

The location where the device address must be specified also depends on the host language that you are using. In some languages, this could be specified outside the output command. In BASIC, this is always specified after the keyword OUTPUT. The examples in this manual use a generic address of XXX. When writing programs, the number you use will depend on the cable you use, in addition to the actual address. If you are using an HP-IB, see chapter 2, "Programming over HP-IB." If you are using RS-232C, see chapter 3, "Programming Over RS-232C." If you are using the HP 16500L LAN option, see chapter 3 in the *HP 16500L User's Reference*.

Instructions

Instructions (both commands and queries) normally appear as a string embedded in a statement of your host language, such as BASIC, Pascal or C. The only time a parameter is not meant to be expressed as a string is when the instruction's syntax definition specifies <block_data>. There are just a few instructions which use block data.

Instructions are composed of two main parts: the header, which specifies the command or query to be sent; and the parameters, which provide additional data needed to clarify the meaning of the instruction. Many queries do not use any parameters.

Instruction Header

The instruction header is one or more keywords separated by colons (:). The command tree for the mainframe in figure 4-1 illustrates how all the keywords can be joined together to form a complete header (see chapter 4, "Programming and Documentation Conventions").

The example in figure 1-1 shows a command. Queries are indicated by adding a question mark (?) to the end of the header. Many instructions can be used as either commands or queries, depending on whether or not you have included the question mark. The command and query forms of an instruction usually have different parameters.

When you look up a query in this programmer's reference, you'll find a paragraph labeled "Returned Format" under the one labeled "Query." The syntax definition by "Returned format" will always show the instruction header in square brackets, like [:SYSTem:MENU], which means the text between the brackets is optional. It is also a quick way to see what the header looks like.

White Space

White space is used to separate the instruction header from the instruction parameters. If the instruction does not use any parameters, white space does not need to be included. White space is defined as one or more spaces. ASCII defines a space to be a character, represented by a byte, that has a decimal value of 32. Tabs can be used only if your controller first converts them to space characters before sending the string to the system.

Instruction Parameters

Instruction parameters are used to clarify the meaning of the command or query. They provide necessary data, such as: whether a function should be on or off, which waveform is to be displayed, or which pattern is to be looked for. Each instruction's syntax definition shows the parameters, as well as the range of acceptable values they accept. This chapter's "Parameter Data Types" section has all of the general rules about acceptable values.

When there is more than one parameter, they are separated by commas (,). White space surrounding the commas is optional.

Instruction Terminator

An instruction is executed after the instruction terminator is received. The terminator is the NL (New Line) character. The NL character is an ASCII linefeed character (decimal 10).

The NL (New Line) terminator has the same function as an EOS (End Of String) and EOT (End Of Text) terminator.



Header Types

There are three types of headers: Simple Command, Compound Command, and Common Command.

Simple Command Header

Simple command headers contain a single keyword. START and STOP are examples of simple command headers typically used in this logic analyzer. The syntax is: <function><terminator>

When parameters (indicated by <data>) must be included with the simple command header, the syntax is: <function><white_space><data><terminator>

Example

```
:RMODE SINGLE<terminator>
```

Compound Command Header

Compound command headers are a combination of two or more program keywords. The first keyword selects the subsystem, and the last keyword selects the function within that subsystem. Sometimes you may need to list more than one subsystem before being allowed to specify the function. The keywords within the compound header are separated by colons. For example, to execute a single function within a subsystem, use the following: <subsystem>:<function><white_space><data><terminator>

Example

```
:SYSTEM:LONGFORM ON
```

To traverse down one level of a subsystem to execute a subsystem within that subsystem, use the following:

```
<subsystem>:<subsystem>:<function><white_space>  
<data><terminator>
```

Example

```
:MEMORY:LOAD:CONFIG "FILE "
```

Common Command Header

Common command headers control IEEE 488.2 functions within the logic analyzer, such as, clear status. The syntax is:

```
*<command header><terminator>
```

No white space or separator is allowed between the asterisk and the command header. *CLS is an example of a common command header.

Combined Commands in the Same Subsystem

To execute more than one function within the same subsystem, a semicolon (;) is used to separate the functions:

```
:<subsystem>:<function><white space><data>;<function><white space><data><terminator>
```

Example

```
:SYSTEM:LONGFORM ON;HEADER ON
```

Duplicate Keywords

Identical function keywords can be used for more than one subsystem. For example, the function keyword MMODE may be used to specify the marker mode in the subsystem for state listing or the timing waveforms:

- :SLIST:MMODE PATTERN - sets the marker mode to pattern in the state listing.
- :TWAVEFORM:MMODE TIME - sets the marker mode to time in the timing waveforms.

SLIST and TWAVEFORM are subsystem selectors, and they determine which marker mode is being modified.



Query Usage

Logic analysis system instructions that are immediately followed by a question mark (?) are queries. After receiving a query, the logic analysis system parser places the response in the output buffer. The output message remains in the buffer until it is read or until another instruction is issued. When read, the message is transmitted across the bus to the designated listener (typically a controller).

Query commands are used to find out how the system is currently configured. They are also used to get results of measurements made by the modules in the system.

Example

This instruction places the current full-screen time for machine 1 of the logic analyzer module, which is in slot 2, in the output buffer.

```
:SELECT 2:MACHINE1:TWAVEFORM:RANGE?
```

In order to prevent the loss of data in the output buffer, the output buffer must be read before the next program message is sent. Sending another command before reading the result of the query will cause the output buffer to be cleared and the current response to be lost. This will also generate a "QUERY UNTERMINATED" error in the error queue. For example, when you send the query `:SELECT 2:TWAVEFORM:RANGE?` you must follow that with an input statement. In BASIC, this is usually done with an ENTER statement.

In BASIC, the input statement, `ENTER XXX; Range`, passes the value across the bus to the controller and places it in the variable `Range`.

Additional details on how to use queries is in the next section of this chapter, "Receiving Information from the Logic Analysis System."

Program Header Options

Program headers can be sent using any combination of uppercase or lowercase ASCII characters. System responses, however, are always returned in uppercase.

Both program command and query headers may be sent in either long form (complete spelling), short form (abbreviated spelling), or any combination of long form and short form.

Programs written in long form are easily read and are almost self-documenting. The short form syntax conserves the amount of controller memory needed for program storage and reduces the amount of I/O activity.

The rules for short form syntax are discussed in chapter 4, "Programming and Documentation Conventions."

Example

Either of the following examples turns on the headers and long form.
Long form:

```
OUTPUT XXX; ":SYSTEM:HEADER ON;LONGFORM ON"
```

Short form:

```
OUTPUT XXX; ":SYST:HEAD ON;LONG ON"
```



Parameter Data Types

There are three main types of data which are used in parameters. They are numeric, string, and keyword. A fourth type, block data, is used only for a few instructions: the `DATA` and `SETup` instructions in the `SYSTEM` subsystem (see chapter 10); the `CATalog`, `UPLoad`, and `DOWNload` instructions in the `MMEMory` subsystem (see chapter 11). These syntax rules also show how data may be formatted when sent back from the system as a response.

The parameter list always follows the instruction header and is separated from it by white space. When more than one parameter is used, they are separated by commas. You are allowed to include one or more white spaces around the commas, but it is not mandatory.

Numeric data

For numeric data, you have the option of using exponential notation or using suffixes to indicate which unit is being used. However, exponential notation is only applicable to the decimal number base. Do not combine an exponent with a unit.

See Also

Tables 5-1 and 5-2 in chapter 5, "Message Communications and System Functions," list all available suffixes.

Example

The following numbers are all equal:

$$28 = 0.28E2 = 280E-1 = 28000m = 0.028K.$$

The system will recognize binary, octal, and hexadecimal base numbers. The base of a number is specified with a prefix. The recognized prefixes are `#B` for binary, `#Q` for octal, and `#H` for hexadecimal. The absence of a prefix indicates the number is decimal which is the default base.

Example

The following numbers are all equal:

$$\#B11100 = \#Q34 = \#H1C = 28$$

You may not specify a base in conjunction with either exponents or unit suffixes. Additionally, negative numbers must be expressed in decimal. When a syntax definition specifies that a number is an integer, that means that the number should be whole. Any fractional part would be ignored, truncating the number. Numeric parameters that accept fractional values are called real numbers.

All numbers are expected to be strings of ASCII characters. Thus, when sending the number 9, you send a byte representing the ASCII code for the character "9" (which is 57, or 0011 1001 in binary). A three-digit number, like 102, will take up three bytes (ASCII codes 49, 48 and 50). This is taken care of automatically when you include the entire instruction in a string.

String data

String data may be delimited with either single (') or double (") quotes. String parameters representing labels are case-sensitive. For instance, the labels "Bus A" and "bus a" are unique and can not be used interchangeably. Also pay attention to the presence of spaces, because they act as legal characters just like any other. So, the labels "In" and " In" are also two different labels.

Keyword data

In many cases a parameter must be a keyword. The available keywords are always included with the instruction's syntax definition. When sending commands, either the long form or short form (if one exists) may be used. Uppercase and lowercase letters may be mixed freely. When receiving responses, uppercase letters will be used exclusively. The use of long form or short form in a response depends on the setting you last specified via the SYSTem:LONGform command.



Selecting Multiple Subsystems

You can send multiple program commands and program queries for different subsystems within the same selected module on the same line by separating each command with a semicolon. The colon following the semicolon enables you to enter a new subsystem. <instruction header><data>;
:<instruction header><data><terminator>

Multiple commands may be any combination of simple, compound and common commands.

Example

```
:SELECT 2:MACHINE1:ASSIGN2::SYSTEM:HEADERS ON
```

Receiving Information from the Logic Analysis System

After receiving a query (logic analysis system instruction followed by a question mark), the system interrogates the requested function and places the answer in its output queue. The answer remains in the output queue until it is read, or, until another command is issued. When read, the message is transmitted across the bus to the designated listener (typically a controller). The input statement for receiving a response message from system's output queue usually has two parameters: the device address and a format specification for handling the response message.

All results for queries sent in a program message must be read before another program message is sent. For example, when you send the query `:SYSTEM:LONGFORM?`, you must follow that query with an input statement. In BASIC, this is usually done with an ENTER statement.

The format for handling the response messages is dependent on both the controller and the programming language.

Example

To read the result of the query command `:SYSTEM:LONGFORM?` you can execute this BASIC statement to enter the current setting for the long form command in the numeric variable `Setting`.

```
ENTER XXX; Setting
```



Response Header Options

The format of the returned ASCII string depends on the current settings of the SYSTEM HEADER and LONGFORM commands. The general format is <instruction_header><space><data><terminator>

The header identifies the data that follows (the parameters) and is controlled by issuing a :SYSTEM:HEADER ON/OFF command. If the state of the header command is OFF, only the data is returned by the query.

The format of the header is controlled by the :SYSTEM:LONGFORM command. If long form is OFF, the header will be in its short form and the header will vary in length, depending on the particular query. The separator between the header and the data always consists of one space.

A command or query may be sent in either long form or short form, or in any combination of long form and short form. The HEADER and LONGFORM commands only control the format of the returned data, and, they have no affect on the way commands are sent.

Examples

The following examples show some possible responses for a :SELECT 2:MACHINE1:SFORMAT:THRESHOLD2? query:
with HEADER OFF:

```
<data><terminator>
```

with HEADER ON and LONGFORM OFF:

```
:SEL 2:MACH1:SFOR:THR2 <white_space><data><terminator>
```

with HEADER ON and LONGFORM ON:

```
:SELECT 2:MACHINE1:SFORMAT:THRESHOLD2 <white_space>  
<data><terminator>
```

See Also

Chapter 10, "SYSTEM Subsystem" for information on turning the HEADER and LONGFORM commands on and off.

Response Data Formats

Both numbers and strings are returned as a series of ASCII characters, as described in the following sections. Keywords in the data are returned in the same format as the header, as specified by the LONGform command. Like the headers, the keywords will always be in uppercase.

Examples

The following are possible responses to the :SELECT 2:MACHINE1:TFORMAT: LAB? 'ADDR' query.

Header on; Longform on

```
:SELECT 2:MACHINE1:TFORMAT:LABEL "ADDR " ,19,  
POSITIVE<terminator>
```

Header on; Longform off

```
:SEL 2:MACH1:TFOR:LAB "ADDR " ,19,POS<terminator>
```

Header off; Longform on

```
"ADDR " ,19,POSITIVE<terminator>
```

Header off; Longform off

```
"ADDR " ,19,POS<terminator>
```

See Also

The individual commands in Part 2 of this guide contain information on the format (alpha or numeric) of the data returned from each query.



String Variables

Because there are so many ways to code numbers, the HP 16500B Logic Analysis System handles almost all data as ASCII strings. Depending on your host language, you may be able to use other types when reading in responses. Sometimes it is helpful to use string variables in place of constants to send instructions to the system, such as, including the headers with a query response.

Example

This example combines variables and constants in order to make it easier to switch from MACHINE1 to MACHINE2 in slot 3. In BASIC, the & operator is used for string concatenation.

```
10 LET Machine$ = ":SELECT 3:MACHINE2" !Send all instructions to machine 2 in
!slot 3
20 OUTPUT XXX; Machine$ & ":TYPE STATE" !Make machine a state analyzer
30 ! Assign all labels to be positive
40 OUTPUT XXX; Machine$ & ":SFORMAT:LABEL 'CHAN 1', POS"
50 OUTPUT XXX; Machine$ & ":SFORMAT:LABEL 'CHAN 2', POS"
60 OUTPUT XXX; Machine$ & ":SFORMAT:LABEL 'OUT', POS"
99 END
```

If you want to observe the headers for queries, you must bring the returned data into a string variable. Reading queries into string variables requires little attention to formatting.

Example

This command line places the output of the query in the string variable Result\$.

```
ENTER XXX;Result$
```

In the language used for this guide (HP BASIC 6.2), string variables are case-sensitive and must be expressed exactly the same each time they are used. The output of the system may be numeric or character data depending on what is queried. Refer to the specific commands, in Part 2 of this guide, for the formats and types of data returned from queries.

Example

The following example shows logic analyzer module data being returned to a string variable with headers off:

```
10 OUTPUT XXX;" :SYSTEM:HEADER OFF"  
20 DIM Rang$[ 30 ]  
30 OUTPUT XXX;" :SELECT 2:MACHINE1:TWAVEFORM:RANGE?"  
40 ENTER XXX;Rang$  
50 PRINT Rang$  
60 END
```

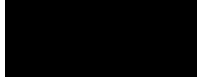
After running this program, the controller displays: +1.00000E-05

Numeric Base

Most numeric data will be returned in the same base as shown on screen. When the prefix #B precedes the returned data, the value is in the binary base. Likewise, #Q is the octal base and #H is the hexadecimal base. If no prefix precedes the returned numeric data, then the value is in the decimal base.

Numeric Variables

If your host language can convert from ASCII to a numeric format, then you can use numeric variables. Turning off the response headers will help you avoid accidentally trying to convert the header into a number.



Example

The following example shows logic analyzer module data being returned to a numeric variable.

```
10 OUTPUT XXX;" :SYSTEM:HEADER OFF"  
20 OUTPUT XXX;" :SELECT 2:MACHINE1:TWAVEFORM:RANGE?"  
30 ENTER XXX;Rang  
40 PRINT Rang  
50 END
```

This time the format of the number (whether or not exponential notation is used) is dependant upon your host language. In BASIC, the output will look like: 1.E-5

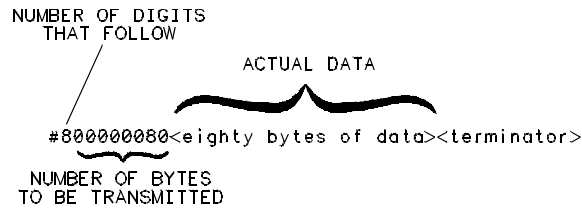
Definite-Length Block Response Data

Definite-length block response data, also referred to as block data, allows any type of device-dependent data to be transmitted over the system interface as a series of data bytes. Definite-length block data is particularly useful for sending large quantities of data, or, for sending 8-bit extended ASCII codes. The syntax is a pound sign (#) followed by a non-zero digit representing the number of digits in the decimal integer. Following the non zero digit is the decimal integer that states the number of 8-bit data bytes to follow. This number is followed by the actual data.

Indefinite-length block data is not supported on the HP16500B Logic Analysis System.

For example, for transmitting 80 bytes of data, the syntax would be:

Figure 1-2



16500/BL22

Definite-length Block Response Data

The "8" states the number of digits that follow, and "00000080" states the number of bytes to be transmitted, which is 80.

Multiple Queries

You can send multiple queries to the system within a single program message, but you must also read them back within a single program message. This can be accomplished by either reading them back into a string variable or into multiple numeric variables.

Example

You can read the result of the query `:SYSTEM:HEADER?;LONGFORM?` into the string variable `Results$` with the command:

```
ENTER XXX; Results$
```

When you read the result of multiple queries into string variables, each response is separated by a semicolon.



Example

The response of the query :SYSTEM:HEADER?:LONGFORM? with HEADER and LONGFORM turned on is:

```
:SYSTEM:HEADER 1;:SYSTEM:LONGFORM 1
```

If you do not need to see the headers when the numeric values are returned, then you could use numeric variables. When you are receiving numeric data into numeric variables, the headers should be turned off. Otherwise the headers may cause misinterpretation of returned data.

Example

The following program message is used to read the query :SYSTEM:HEADERS?:LONGFORM? into multiple numeric variables:

```
ENTER XXX; Result1, Result2
```

System Status

Status registers track the current status of the mainframe and the installed modules. By checking the system status, you can find out whether an operation has been completed, whether a module is receiving triggers, and more.

See Also

Chapter 6, "Status Reporting," explains how to check the status of the system and the installed modules.





Programming Over HP-IB

Introduction

This section describes the interface functions and some general concepts of the HP-IB. In general, these functions are defined by IEEE 488.1 (HP-IB bus standard). They deal with general bus management issues, as well as messages which can be sent over the bus as bus commands.

Interface Capabilities

The interface capabilities of the HP 16500B, as defined by IEEE 488.1 are SH1, AH1, T5, TE0, L3, LE0, SR1, RL1, PP0, DC1, DT1, C0, and E2.

Command and Data Concepts

The HP-IB has two modes of operation: command mode and data mode. The bus is in command mode when the ATN line is true. The command mode is used to send talk and listen addresses and various bus commands, such as a group execute trigger (GET). The bus is in the data mode when the ATN line is false. The data mode is used to convey device-dependent messages across the bus. These device-dependent messages include all of the commands and responses found in chapters 9 through 12 of this guide for the mainframe and the respective *Programmer's Guides* for each module installed in the mainframe.

Talk/Listen Addressing

By using the touchscreen fields in the System Configuration menu, the HP-IB interface can be placed in either talk only mode, "Printer connected to HP-IB," or in addressed talk/listen mode, "Controller connected to HP-IB."

See Also

Chapter 4, "The HP-IB and RS-232C Interfaces" in the *HP 16500B User's Reference*)

Talk only mode must be used when you want the system to talk directly to a printer without the aid of a controller. Addressed talk/listen mode is used when the system will operate in conjunction with a controller. When the system is in the addressed talk/listen mode, the following is true:

- Each device on the HP-IB resides at a particular address ranging from 0 to 30.
- The active controller specifies which devices will talk and which will listen.
- An instrument, therefore, may be talk-addressed, listen-addressed, or unaddressed by the controller.

If the controller addresses the instrument to talk, it will remain configured to talk until it receives:

- an interface clear message (IFC)
- another instrument's talk address (OTA)
- its own listen address (MLA)
- a universal untalk (UNT) command.

If the controller addresses the instrument to listen, it will remain configured to listen until it receives:

- an interface clear message (IFC)
- its own talk address (MTA)
- a universal unlisten (UNL) command.

HP-IB Bus Addressing

Because HP-IB can address multiple devices through the same interface card, the device address passed with the program message must include not only the correct instrument address, but also the correct interface code.

Interface Select Code (Selects the Interface)

Each interface card has its own interface select code. This code is used by the controller to direct commands and communications to the proper interface. The default is always "7" for HP-IB controllers.



Instrument Address (Selects the Instrument)

Each instrument on the HP-IB port must have a unique instrument address between decimals 0 and 30. The device address passed with the program message must include not only the correct instrument address, but also the correct interface select code.

Example

For example, if the instrument address is 4 and the interface select code is 7, the instruction will cause an action in the instrument at device address 704.

$$\text{DEVICE ADDRESS} = (\text{Interface Select Code}) \times 100 + (\text{Instrument Address})$$

Local, Remote, and Local Lockout

The local, remote, and remote with local lockout modes may be used for various degrees of front-panel control while a program is running. The logic analysis system will accept and execute bus commands while in local mode, and the front panel will also be entirely active. If the HP 16500B is in remote mode, the system will go from remote to local with any touchscreen, mouse, or keyboard activity. In remote with local lockout mode, all controls (except the power switch) are entirely locked out. Local control can only be restored by the controller.

Hint

Cycling the power will also restore local control, but this will also reset certain HP-IB states. It also resets the system to the power-on defaults and purges any acquired data in the acquisition memory of all the installed modules.

The instrument is placed in remote mode by setting the REN (Remote Enable) bus control line true, and then addressing the instrument to listen. The instrument can be placed in local lockout mode by sending the local lockout (LLO) command. The instrument can be returned to local mode by either setting the REN line false, or sending the instrument the go to local (GTL) command.

See Also

:SYSTem:LOCKout in chapter 9, "Mainframe Commands"

Bus Commands

The following commands are IEEE 488.1 bus commands (ATN true). IEEE 488.2 defines many of the actions which are taken when these commands are received by the system.

Device Clear

The device clear (DCL) or selected device clear (SDC) commands clear the input and output buffers, reset the parser, clear any pending commands, and clear the Request-OPC flag.

Group Execute Trigger (GET)

The group execute trigger command will cause the same action as the START command for Group Run: the instrument will acquire data for the active waveform and listing displays.


Interface Clear (IFC)

This command halts all bus activity. This includes unaddressing all listeners and the talker, disabling serial poll on all devices, and returning control to the system controller.



Programming Over RS-232C

Introduction



This chapter describes the interface functions and some general concepts of the RS-232C. The RS-232C interface on this instrument is Hewlett-Packard's implementation of EIA Recommended Standard RS-232C, *"Interface Between Data Terminal Equipment and Data Communications Equipment Employing Serial Binary Data Interchange."* With this interface, data is sent one bit at a time, and characters are not synchronized with preceding or subsequent data characters. Each character is sent as a complete entity without relationship to other events.

Interface Operation

The HP 16500B Logic Analysis System can be programmed with a controller over RS-232C using either a minimum three-wire or extended hardware interface. The operation and exact connections for these interfaces are described in more detail in the following sections. When you are programming an HP 16500B Logic Analysis System over RS-232C with a controller, you are normally operating directly between two DTE (Data Terminal Equipment) devices as compared to operating between a DTE device and a DCE (Data Communications Equipment) device.

When operating directly between two DTE devices, certain considerations must be taken into account. For a three-wire operation, XON/XOFF must be used to handle protocol between the devices. For extended hardware operation, protocol may be handled either with XON/XOFF or by manipulating the CTS and RTS lines of the RS-232C link. For both three-wire and extended hardware operation, the DCD and DSR inputs to the logic analysis system must remain high for proper operation.

With extended hardware operation, a high on the CTS input allows the logic analysis system to send data, and a low disables the logic analysis system data transmission. Likewise, a high on the RTS line allows the controller to send data, and a low signals a request for the controller to disable data transmission. Because three-wire operation has no control over the CTS input, internal pull-up resistors in the logic analysis system assure that this line remains high for proper three-wire operation.

RS-232C Cables

Selecting a cable for the RS-232C interface depends on your specific application, and, whether you wish to use software or hardware handshake protocol. The following paragraphs describe which lines of the HP 16500B Logic Analysis system are used to control the handshake operation of the RS-232C relative to the system. To locate the proper cable for your application, refer to the reference manual for your computer or controller. Your computer or controller manual should describe the exact handshake protocol your controller can use to operate over the RS-232C bus. Also in this chapter you will find HP cable recommendations for hardware handshake.

Minimum Three-Wire Interface with Software Protocol

With a three-wire interface, the software (as compared to interface hardware) controls the data flow between the logic analysis system and the controller. The three-wire interface provides no hardware means to control data flow between the controller and the logic analysis system. Therefore, XON/OFF protocol is the only means to control this data flow. The three-wire interface provides a much simpler connection between devices since you can ignore hardware handshake requirements.

The communications software you are using in your computer/controller must be capable of using XON/XOFF exclusively in order to use three-wire interface cables. For example, some communications software packages can use XON/XOFF but are also dependent on the CTS, and DSR lines being true to communicate.

The logic analysis system uses the following connections on its RS-232C interface for three-wire communication:

- Pin 7 SGND (Signal Ground)
- Pin 2 TD (Transmit Data from logic analysis system)
- Pin 3 RD (Receive Data into logic analysis system)

The TD (Transmit Data) line from the logic analysis system must connect to the RD (Receive Data) line on the controller. Likewise, the RD line from the logic analysis system must connect to the TD line on the controller. Internal pull-up resistors in the logic analysis system assure the DCD, DSR, and CTS lines remain high when you are using a three-wire interface.

Extended Interface with Hardware Handshake

With the extended interface, both the software and the hardware can control the data flow between the logic analysis system and the controller. This allows you to have more control of data flow between devices. The logic analysis system uses the following connections on its RS-232C interface for extended interface communication:

- Pin 7 SGND (Signal Ground)
- Pin 2 TD (Transmit Data from logic analysis system)
- Pin 3 RD (Receive Data into logic analysis system)

The additional lines you use depends on your controller's implementation of the extended hardware interface.

- Pin 4 RTS (Request To Send) is an output from the logic analysis system which can be used to control incoming data flow.
- Pin 5 CTS (Clear To Send) is an input to the logic analysis system which controls data flow from the logic analysis system.
- Pin 6 DSR (Data Set Ready) is an input to the logic analysis system which controls data flow from the logic analysis system within two bytes.
- Pin 8 DCD (Data Carrier Detect) is an input to the logic analysis system which controls data flow from the logic analysis system within two bytes.
- Pin 20 DTR (Data Terminal Ready) is an output from the logic analysis system which is enabled as long as the logic analysis system is turned on.

The TD (Transmit Data) line from the logic analysis system must connect to the RD (Receive Data) line on the controller. Likewise, the RD line from the logic analysis system must connect to the TD line on the controller.

The RTS (Request To Send), is an output from the logic analysis system which can be used to control incoming data flow. A true on the RTS line allows the controller to send data and a false signals a request for the controller to disable data transmission.

The CTS (Clear To Send), DSR (Data Set Ready), and DCD (Data Carrier Detect) lines are inputs to the logic analysis system, which control data flow from the logic analysis system. Internal pull-up resistors in the logic analysis system assure the DCD and DSR lines remain high when they are not connected. If DCD or DSR are connected to the controller, the controller must keep these lines along with the CTS line high to enable the logic analysis system to send data to the controller. A low on any one of these

lines will disable the logic analysis system data transmission. Pulling the CTS line low during data transmission will stop logic analysis system data transmission immediately. Pulling either the DSR or DCD line low during data transmission will stop logic analysis system data transmission, but as many as two additional bytes may be transmitted from the logic analysis system.

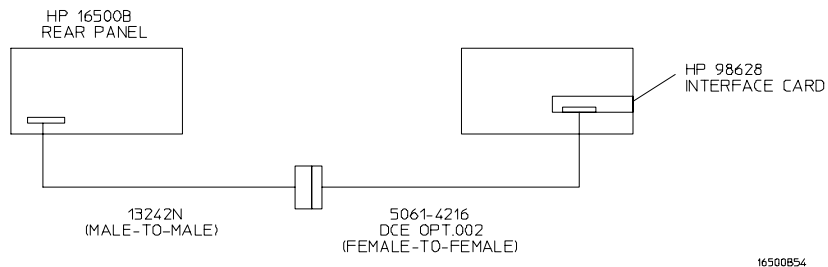
Cable Examples

HP 9000 Series 300

Figure 3-1 is an example of how to connect the HP 16500B Logic Analysis System to the HP 98628A Interface card of an HP 9000 series 300 controller. For more information on cabling, refer to the reference manual for your specific controller.

Because this example does not have the correct connections for hardware handshake, you must use the XON/XOFF protocol when connecting the logic analysis system.

Figure 3-1



Cable Example

HP Vectra Personal Computers and Compatibles

Figures 3-2 through 3-4 give examples of three cables that will work for the extended interface with hardware handshake. Keep in mind that these cables should work if your computer's serial interface supports the four common RS-232C handshake signals as defined by the RS-232C standard. The four common handshake signals are Data Carrier Detect (DCD), Data Terminal Ready (DTR), Clear to Send (CTS), and Ready to Send (RTS).

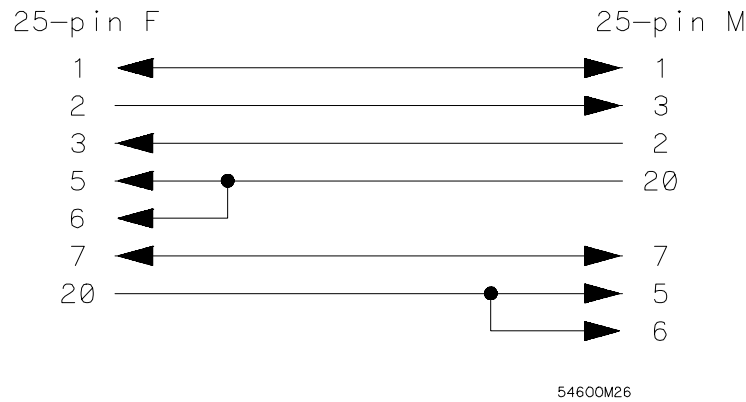
Figure 3-2 shows the schematic of a 25-pin female to 25-pin male cable. The following HP cables support this configuration:

- HP 17255D, DB-25(F) to DB-25(M), 1.2 meter
- HP 17255F, DB-25(F) to DB-25(M), 1.2 meter, shielded.

In addition to the female-to-male cables with this configuration, a male-to-male cable 1.2 meters in length is also available:

- HP 17255M, DB-25(M) to DB-25(M), 1.2 meter

Figure 3-2



25-pin (F) to 25-pin (M) Cable

Figure 3-3 shows the schematic of a 25-pin male to 25-pin male cable 5 meters in length. The following HP cable supports this configuration:

- HP 13242G, DB-25(M) to DB-25(M), 5 meter

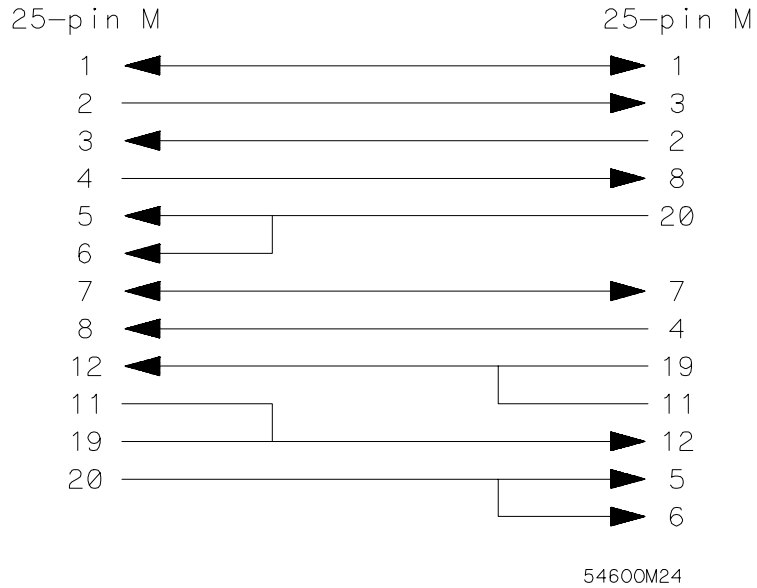


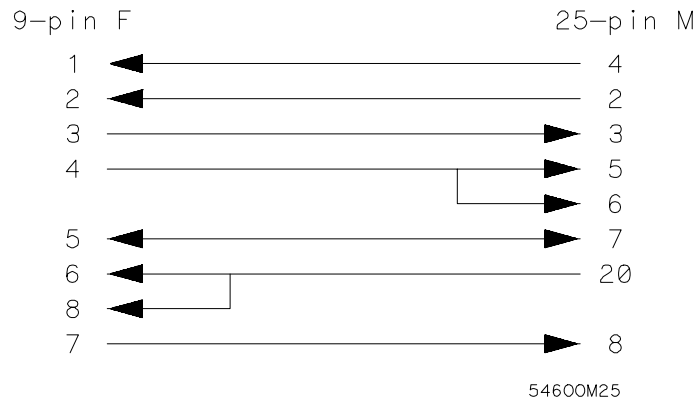
Figure 3-3

25-pin (M) to 25-pin (M) Cable

Figure 3-4 shows the schematic of a 9-pin female to 25-pin male cable. The following HP cables support this configuration:

- HP 24542G, DB-9(F) to DB-25(M), 3 meter
- HP 24542H, DB-9(F) to DB-25(M), 3 meter, shielded
- HP 45911-60009, DB-9(F) to DB-25(M), 1.5 meter

Figure 3-4



9-pin (F) to 25-pin (M) Cable

Configuring the Logic Analysis System Interface

The RS-232C menu field in the System Configuration Menu allows you access to the RS-232C Configuration menu where the RS-232C interface is configured. If you are not familiar with how to configure the RS-232C interface, refer to chapter 4, "The HP-IB and RS232-C Interfaces" in the *HP 16500B Logic Analysis System User's Reference*.

Interface Capabilities

The baud rate, stop bits, parity, protocol, and data bits must be configured exactly the same for both the controller and the logic analysis system to properly communicate over the RS-232C bus. The RS-232C interface capabilities of the HP 16500B Logic Analysis System are listed below:

- Baud Rate: 110, 300, 600, 1200, 2400, 4800, 9600, or 19.2k
- Stop Bits: 1, 1.5, or 2
- Parity: None, Odd, or Even
- Protocol: None or XON/XOFF
- Data Bits: 8

Protocol

NONE With a three-wire interface, selecting NONE for the protocol does not allow the sending or receiving device to control data flow. No control over the data flow increases the possibility of missing data or transferring incomplete data.

With an extended hardware interface, selecting NONE allows a hardware handshake to occur. With hardware handshake, the hardware signals control data flow.

XON/XOFF XON/XOFF stands for Transmit On/Transmit Off. With this mode, the receiver (controller or logic analysis system) controls data flow, and, can request that the sender (logic analysis system or controller) stop data flow. By sending XOFF (ASCII 19) over its transmit data line, the receiver requests that the sender disables data transmission. A subsequent XON (ASCII 17) allows the sending device to resume data transmission.

Data Bits

Data bits are the number of bits sent and received per character that represent the binary code of that character. Characters consist of either 7 or 8 bits, depending on the application. The HP 16500B Logic Analysis System supports 8 bit only.

8 Bit Mode Information is usually stored in bytes (8 bits at a time). With 8-bit mode, you can send and receive data just as it is stored, without the need to convert the data.

The controller and the HP 16500B Logic Analysis System must be in the same bit mode to properly communicate over the RS-232C. This means that the controller must have the capability to send and receive 8 bit data.

See Also

For more information on the RS-232C interface, refer to the *HP 16500B Logic Analysis System User's Reference*. For information on RS-232C voltage levels and connector pinouts, refer to the *HP 16500B Logic Analysis System Service Guide*.

RS-232C Bus Addressing

The RS-232C address you must use is dependent on the computer or controller you are using to communicate with the logic analysis system.

HP Vectra Personal Computers or compatibles

If you are using an HP Vectra Personal Computer or compatible, it must have an unused serial port to which you connect the logic analysis system's RS-232C port. The proper address for the serial port is dependent on the hardware configuration of your computer. Additionally, your communications software must be configured to address the proper serial port. Refer to your computer and communications software manuals for more information on setting up your serial port address.

HP 9000 Series 300 Controllers

Each RS-232C interface card for the HP 9000 Series 300 Controller has its own interface select code. This code is used by the controller for directing commands and communications to the proper interface by specifying the correct interface code for the device address.

Generally, the interface select code can be any decimal value between 0 and 31, except for those interface codes which are reserved by the controller for internal peripherals and other internal interfaces. This value can be selected through switches on the interface card. For example, if your RS-232C interface select code is 9, the device address required to communicate over the RS-232C bus is 9. For more information, refer to the reference manual for your interface card or controller.

Lockout Command

To lockout the front-panel controls, use the SYSTem command LOCKout. When this function is on, all controls (except the power switch) are entirely locked out. Local control can only be restored by sending the :LOCKout OFF command.

Hint

Cycling the power will also restore local control, but this will also reset certain RS-232C states. It also resets the logic analysis system to the power-on defaults and purges any acquired data in the acquisition memory of all the installed modules.


See Also

For more information on this command see chapter 10, "System Commands."



Programming and Documentation Conventions

Introduction



This chapter covers the programming conventions used in programming the instrument, as well as the documentation conventions used in this manual. This chapter also contains a detailed description of the command tree and command tree traversal.

Truncation Rule

The truncation rule for the keywords used in headers and parameters is:

- If the long form has four or fewer characters, there is no change in the short form. When the long form has more than four characters the short form is just the first four characters, unless the fourth character is a vowel. In that case only the first three characters are used.

There are some commands that do not conform to the truncation rule by design. These will be noted in their respective description pages.

Some examples of how the truncation rule is applied to various commands are shown in table 4-1.

Table 4-1

Truncation Examples

Long Form	Short Form
OFF	OFF
DATA	DATA
START	STAR
LONGFORM	LONG
DELAY	DEL
ACCUMULATE	ACC

Infinity Representation

The representation of infinity is 9.9E+37 for real numbers and 32767 for integers. This is also the value returned when a measurement cannot be made.

Sequential and Overlapped Commands

IEEE 488.2 makes the distinction between sequential and overlapped commands. Sequential commands finish their task before the execution of the next command starts. Overlapped commands run concurrently; therefore, the command following an overlapped command may be started before the overlapped command is completed. The overlapped commands for the HP 16500B Logic Analysis System are *START* and *STOP*.

Response Generation

IEEE 488.2 defines two times at which query responses may be buffered. The first is when the query is parsed by the instrument and the second is when the controller addresses the instrument to talk so that it may read the response. The HP 16500B Logic Analysis System will buffer responses to a query when it is parsed.

Syntax Diagrams

At the beginning of each chapter in Part 2, "Commands," is a syntax diagram showing the proper syntax for each command. All characters contained in a circle or oblong are literals, and must be entered exactly as shown. Words and phrases contained in rectangles are names of items used with the command and are described in the accompanying text of each command. Each line can only be entered from one direction as indicated by the arrow

on the entry line. Any combination of commands and arguments that can be generated by following the lines in the proper direction is syntactically correct. An argument is optional if there is a path around it. When there is a rectangle which contains the word "space," a white space character must be entered. White space is optional in many other places.

Notation Conventions and Definitions

The following conventions are used in this manual when describing programming rules and example.

- < > Angular brackets enclose words or characters that are used to symbolize a program code parameter or a bus command
- ::= "is defined as." For example, A ::= B indicates that A can be replaced by B in any statement containing A.
- | "or." Indicates a choice of one element from a list. For example, A | B indicates A or B, but not both.
- . . . An ellipsis (trailing dots) is used to indicate that the preceding element may be repeated one or more times.
- [] Square brackets indicate that the enclosed items are optional.
- { } When several items are enclosed by braces and separated by vertical bars (|), one, and only one of these elements must be selected.
- xxx Three Xs after an ENTER or OUTPUT statement represent the device address required by your controller.
- <NL> Linefeed (ASCII decimal 10).

The Command Tree

The command tree (figure 4-1) shows all commands in the HP 16500B Logic Analysis System and the relationship of the commands to each other. You should notice that the common commands are not actually connected to the

other commands in the command tree. After a <NL> (linefeed - ASCII decimal 10) has been sent to the instrument, the parser will be set to the root of the command tree. Parameters are not shown in this figure. The command tree allows you to see what the system's parser expects to receive. All legal headers can be created by traversing down the tree, adding keywords until the end of a branch has been reached.

Command Types

As shown in chapter 1, "Header Types," there are three types of headers. Each header has a corresponding command type. This section shows how they relate to the command tree.

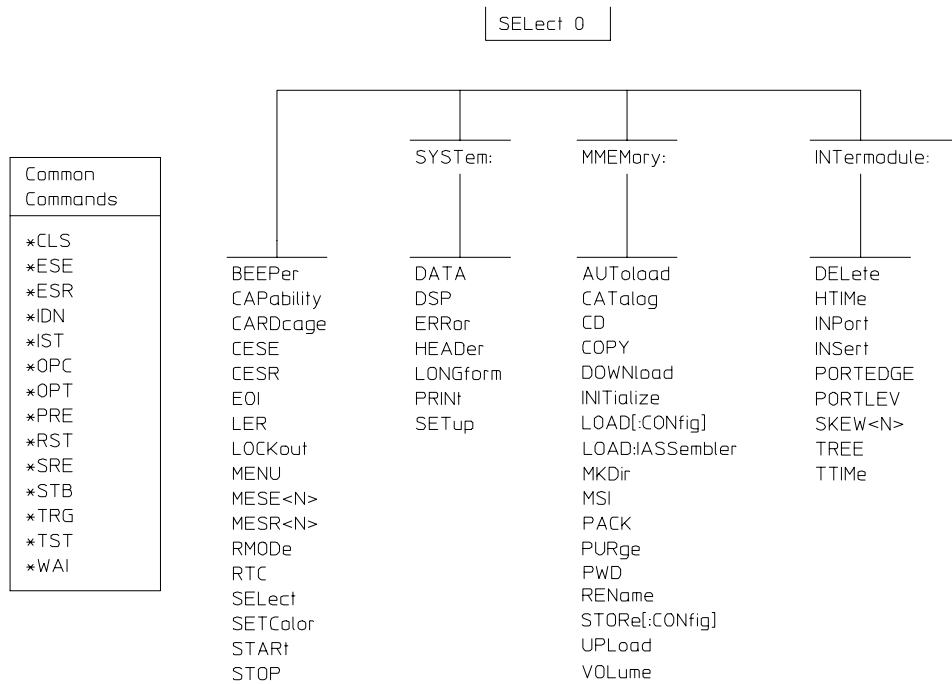
System Commands The system commands reside at the top level of the command tree. These commands are always parsable if they occur at the beginning of a program message, or are preceded by a colon. *START* and *STOP* are examples of system commands.

Subsystem Commands Subsystem commands are grouped together under a common node of the tree, such as the *MEMORY* commands.

Common Commands Common commands are independent of the tree, and do not affect the position of the parser within the tree. **CLS* and **RST* are examples of common commands.

Figure 4-1

HP 16500B Command Tree



16500B56

Tree Traversal Rules

Command headers are created by traversing down the command tree. A legal command header from the command tree in figure 4-1 would be **:MMEMORY: INITIALIZE**. This is referred to as a compound header. As shown on the tree, branches are always preceded by colons. Do not add spaces around the colons. The following two rules apply to traversing the tree:

- A leading colon (the first character of a header) or a terminator places the parser at the root of the command tree. For example, the colon preceding **MMEMORY (:MMEMORY)** in the above example places the parser at the root of the command tree.
- Executing a subsystem command places you in that subsystem until a leading colon or a terminator is found. The parser will stay at the colon

above the keyword where the last header terminated. Any command below that point can be sent within the current program message without sending the keywords(s) which appear above them. For example, the colon separating MMEMORY and INITIALIZE is the location of the parser when this compound header is parsed.

The following examples are written using HP BASIC 6.2 on a HP 9000 Series 300 Controller. The quoted string is placed on the bus, followed by a carriage return and linefeed (CRLF). The three Xs (XXX) shown in this manual after an ENTER or OUTPUT statement represents the device address required by your controller.

Example 1

In this example, the colon between SYSTEM and HEADER is necessary since SYSTEM:HEADER is a compound command. The semicolon between the HEADER command and the LONGFORM command is the required <program message unit separator>. The LONGFORM command does not need SYSTEM preceding it, since the SYSTEM:HEADER command sets the parser to the SYSTEM node in the tree.

```
OUTPUT XXX; ":SYSTEM:HEADER ON;LONGFORM ON"
```

Example 2

In the first line of this example, the subsystem selector is implied for the STORE command in the compound command. The STORE command must be in the same program message as the INITIALIZE command, since the <program message terminator> will place the parser back at the root of the command tree.

A second way to send these commands is by placing MMEMORY: before the STORE command as shown in the fourth line of this example 2.

```
OUTPUT XXX;":MMEMORY:INITIALIZE;STORE 'FILE ', 'FILE  
DESCRIPTION' "
```

OR

```
OUTPUT XXX;":MMEMORY:INITIALIZE"  
OUTPUT XXX;":MMEMORY:STORE 'FILE ', 'FILE DESCRIPTION' "
```

Example 3

In this example, the leading colon before SYSTEM tells the parser to go back to the root of the command tree. The parser can then see the SYSTEM:PRINT command.

```
OUTPUT XXX;":MMEM:CATALOG?;:SYSTEM:PRINT ALL"
```

Command Set Organization

The command set for the HP 16500B Logic Analysis System mainframe is divided into 5 separate groups as shown in figure 4-1. The command groups are: common commands, mainframe commands, and 3 sets of subsystem commands. In addition to the command tree in figure 4-1, a command to subsystem cross-reference is shown in table 4-2.

Each of the 5 groups of commands is described in a separate chapter in Part 2, "Commands." Each of the chapters contain a brief description of the subsystem, a set of syntax diagrams for those commands, and finally, the commands for that subsystem in alphabetical order.

Subsystems

The commands are shown in the long form and short form using upper and lowercase letters. As an example, `AUToLoad` indicates that the long form of the command is `AUTOLOAD` and the short form of the command is `AUT`. Each of the commands contain a description of the command, its arguments, and the command syntax.

Subsystems

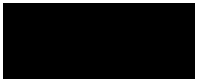
There are three subsystems in the mainframe. In the command tree (figure 4-1) they are shown as branches, with the node above showing the name of the subsystem. Only one subsystem may be selected at a time. At power on, the command parser is set to the root of the command tree; therefore, no subsystem is selected. The three subsystems in the HP 16500B Logic Analysis System are:

- `SYSTEM` - controls some BASIC functions of the instrument.
- `MMEMORY` - provides access to the internal disk drive.
- `INTERMODULE` - provides access to the Intermodule bus (IMB).

Table 4-2

Alphabetic Command Cross-Reference

*CLS	Common	LER	Mainframe
*ESE	Common	LOAD	MMEMory
*ESR	Common	LOCKout	Mainframe
*IDN	Common	LONGform	SYSTEM
*IST	Common	MENU	Mainframe
*OPC	Common	MESE	Mainframe
*OPT	Common	MESR	Mainframe
*PRE	Common	MKDir	MMEMory
*RST	Common	MSI	MMEMory
*SRE	Common	PACK	MMEMory
*STB	Common	PORTedge	INTermodule
*TRG	Common	PORTlev	INTermodule
*TST	Common	PRINt	SYSTEM
*WAI	Common	PURGe	MMEMory
AUToload	MMEMory	PWD	MMEMory
BEEPPer	Mainframe	REName	MMEMory
CAPability	Mainframe	RMODE	Mainframe
CARDcage	Mainframe	RTC	Mainframe
CATalog	MMEMory	SElect	Mainframe
CD	MMEMory	SETColor	Mainframe
CESE	Mainframe	SKEW	INTermodule
CESR	Mainframe	STARt	Mainframe
COPY	MMEMory	STOP	Mainframe
DATA	SYSTEM	STORe	MMEMory
DElete	INTermodule	STup	SYSTEM
DOWNload	MMEMory	TREE	INTermodule
DSP	SYSTEM	TTIME	INTermodule
EOI	Mainframe	UPLoad	MMEMory
ERRor	SYSTEM	VOLUME	MMEMory
HEADer	SYSTEM		
HTIME	INTermodule		
INITialize	MMEMory		
INPort	INTermodule		
INSert	INTermodule		



Program Examples

The program examples in chapter 13, "Programming Examples," were written on an HP 9000 Series 300 controller using the HP BASIC 6.2 language. The programs always assume a generic address for the HP 16500B Logic Analysis System of XXX.

In the examples, you should pay special attention to the ways in which the command and/or query can be sent. Keywords can be sent using either the long form or short form (if one exists for that word). With the exception of some string parameters, the parser is not case-sensitive. Uppercase and lowercase letters may be mixed freely. System commands like `HEADer` and `LONGform` allow you to dictate what forms the responses take, but they have no affect on how you must structure your commands and queries.

Example

The following commands all set the logic analyzer's Timing Waveform Delay to 100 ms.

Keywords in long form, numbers using the decimal format.

```
OUTPUT XXX; ":SELECT 2:MACHINE1:TWAVEFORM:DELAY .1"
```

Keywords in short form, numbers using an exponential format.

```
OUTPUT XXX; ":SEL 2:MACH1:TWAV:DEL 1E-1"
```

Keywords in short form using lowercase letters, numbers using a suffix.

```
OUTPUT XXX; ":sel 2:mach1:twav:del 100ms"
```

In these examples, the colon shown as the first character of the command is optional on the HP 16500B Logic Analysis System. The space between `DElay` and the argument is required.



Message Communication and System Functions

Introduction

This chapter describes the operation of instruments that operate in compliance with the IEEE 488.2 (syntax) standard. It is intended to give you enough basic information about the IEEE 488.2 Standard to successfully program the logic analysis system. You can find additional detailed information about the IEEE 488.2 Standard in ANSI/IEEE Std 488.2-1987, "*IEEE Standard Codes, Formats, Protocols, and Common Commands.*"

The HP 16500B Logic Analysis System is designed to be compatible with other Hewlett-Packard IEEE 488.2 compatible instruments. Instruments that are compatible with IEEE 488.2 must also be compatible with IEEE 488.1 (HP-IB bus standard); however, IEEE 488.1 compatible instruments may or may not conform to the IEEE 488.2 standard. The IEEE 488.2 standard defines the message exchange protocols by which the instrument and the controller will communicate. It also defines some common capabilities, which are found in all IEEE 488.2 instruments. This chapter also contains a few items which are not specifically defined by IEEE 488.2, but deal with message communication or system functions.

The syntax and protocol for RS-232C program messages and response messages for the HP 16500B Logic Analysis System are structured very similar to those described by IEEE 488.2. In most cases, the same structure shown in this chapter for IEEE 488.2 will also work for RS-232C. Because of this, no additional information has been included for RS-232C.

Protocols

The protocols of IEEE 488.2 define the overall scheme used by the controller and the instrument to communicate. This includes defining when it is appropriate for devices to talk or listen, and what happens when the protocol is not followed.

Functional Elements

Before proceeding with the description of the protocol, a few system components should be understood.

Input Buffer The input buffer of the instrument is the memory area where commands and queries are stored prior to being parsed and executed. It allows a controller to send a string of commands to the instrument which could take some time to execute, and then proceed to talk to another instrument while the first instrument is parsing and executing commands.

Output Queue The output queue of the instrument is the memory area where all output data are stored until read by the controller.

Parser The instrument's parser is the component that interprets the commands sent to the instrument and decides what actions should be taken. "Parsing" refers to the action taken by the parser to achieve this goal. Parsing and executing of commands begins when either the instrument recognizes a program message terminator (defined later in this chapter) or the input buffer becomes full. If you wish to send a long sequence of commands to be executed and then talk to another instrument while they are executing, you should send all the commands before sending the program message terminator.

Protocol Overview

The instrument and controller communicate using program messages and response messages. These messages serve as the containers into which sets of program commands or instrument responses are placed. Program messages are sent by the controller to the instrument, and response messages are sent from the instrument to the controller in response to a query message. A query message is defined as being a program message which contains one or more queries. The instrument will only talk when it has received a valid query message, and therefore has something to say. The controller should only attempt to read a response after sending a complete query message, but before sending another program message. An important rule to remember is that the instrument will only talk when prompted to, and it then expects to talk before being told to do something else.

Protocol Operation

When the instrument is turned on, the input buffer and output queue are cleared, and the parser is reset to the root level of the command tree.

The instrument and the controller communicate by exchanging complete program messages and response messages. This means that the controller should always terminate a program message before attempting to read a response. The instrument will terminate response messages except during a hardcopy output.

If a query message is sent, the next message passing over the bus should be the response message. The controller should always read the complete response message associated with a query message before sending another program message to the same instrument.

The instrument allows the controller to send multiple queries in one query message. This is referred to as sending a "compound query." As noted in chapter 1, "Multiple Queries," multiple queries in a query message are separated by semicolons. The responses to each of the queries in a compound query will also be separated by semicolons.

Commands are executed in the order they are received.

Protocol Exceptions

If an error occurs during the information exchange, the exchange may not be completed in a normal manner. Some of the protocol exceptions are shown below.

Command Error A command error will be reported if the instrument detects a syntax error or an unrecognized command header.

Execution Error An execution error will be reported if a parameter is found to be out of range, or if the current settings do not allow execution of a requested command or query.

Device-specific Error A device-specific error will be reported if the instrument is unable to execute a command for a strictly device dependent reason.

Query Error A query error will be reported if the proper protocol for reading a query is not followed. This includes the interrupted and unterminated conditions described in the following paragraphs.

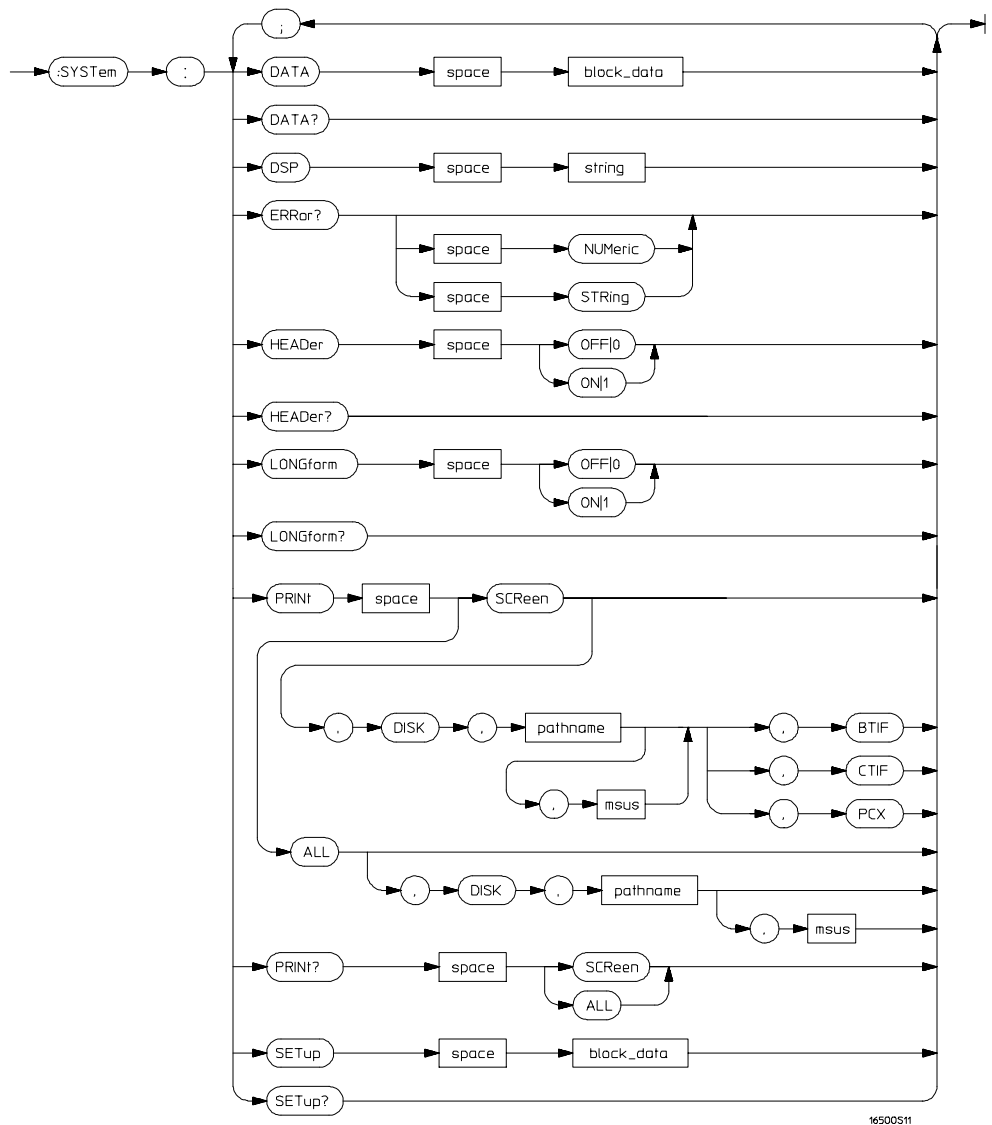


Syntax Diagrams

The example syntax diagram in this chapter is similar to the syntax diagrams in the IEEE 488.2 specification. Commands and queries are sent to the instrument as a sequence of data bytes. The allowable byte sequence for each functional element is defined by the syntax diagram that is shown.

The allowable byte sequence can be determined by following a path in the syntax diagram. The proper path through the syntax diagram is any path that follows the direction of the arrows. If there is a path around an element, that element is optional. If there is a path from right to left around one or more elements, that element or those elements may be repeated as many times as desired.

Figure 5-1



Example syntax diagram

Syntax Overview

This overview is intended to give a quick glance at the syntax defined by IEEE 488.2. It will help you understand many of the things about the syntax you need to know.

IEEE 488.2 defines the blocks used to build messages which are sent to the instrument. A whole string of commands can therefore be broken up into individual components.

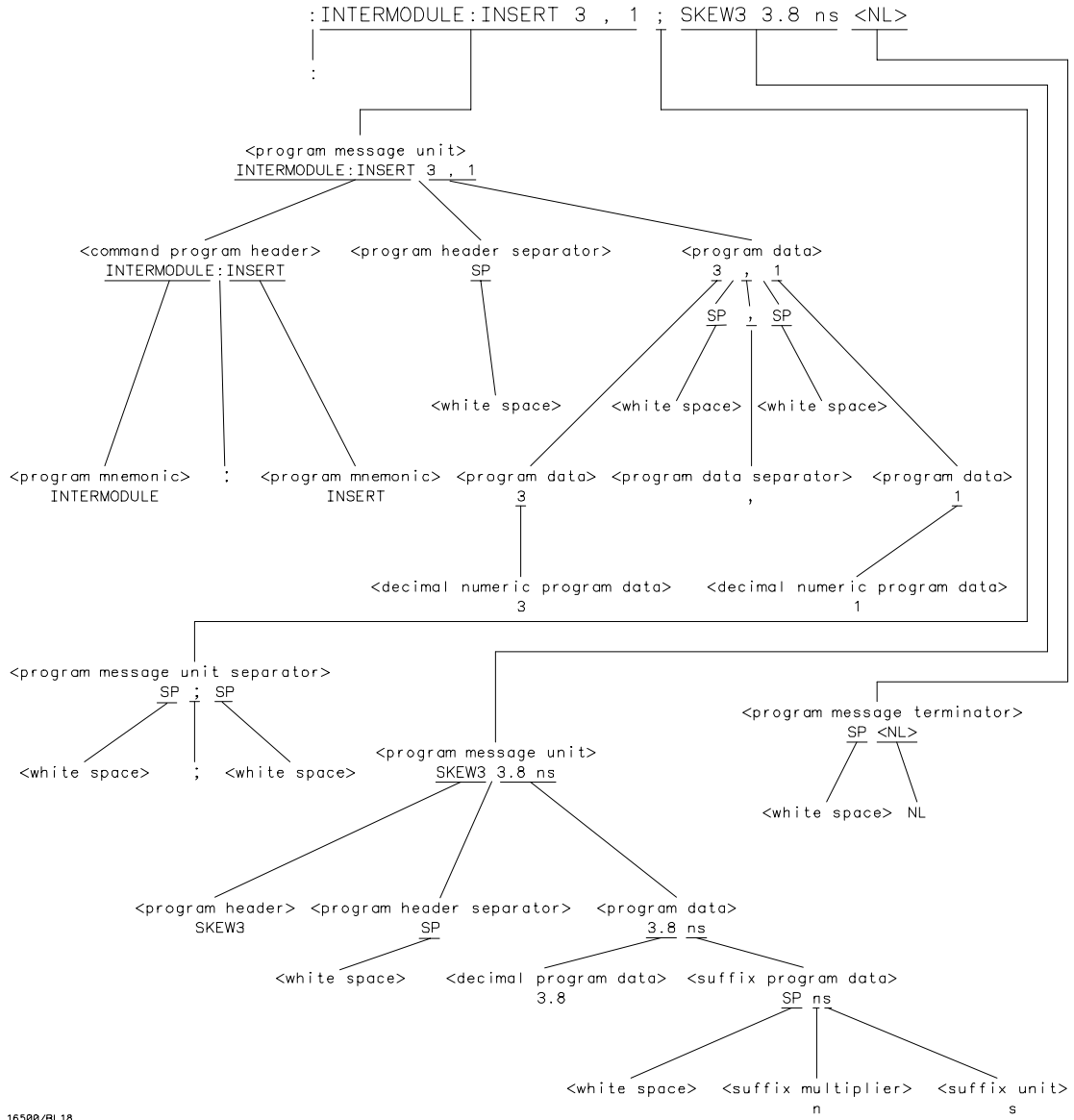
Figure 5-1 is an example syntax diagram and figure 5-2 shows a breakdown of an example program message. There are a few key items to notice:

- A semicolon separates commands from one another. Each program message unit serves as a container for one command. The program message units are separated by a semicolon.
- A program message is terminated by a <NL> (new line). The recognition of the program message terminator, or <PMT>, by the parser serves as a signal for the parser to begin execution of commands. The <PMT> also affects command tree traversal.
- Multiple data parameters are separated by a comma.
- The first data parameter is separated from the header with one or more spaces.
- The header `SYSTEM:LONGFORM OFF` is an example of a compound header. It places the parser in the machine subsystem until the <NL> is encountered.
- A colon preceding the command header returns you to the top of the command tree.

See Also

Chapter 4, "Programming and Documentation Conventions"

Figure 5-2



<program message> Parse Tree

Upper/Lower Case Equivalence

Upper and lower case letters are equivalent. The mnemonic `SINGLE` has the same semantic meaning as the mnemonic `single`.

<white space>

<white space> is defined to be one or more characters from the ASCII set of 0 - 32 decimal, excluding 10 decimal (NL). <white space> is used by several instrument listening components of the syntax. It is usually optional, and can be used to increase the readability of a program.

Suffix Multiplier The suffix multipliers that the instrument will accept are shown in table 5-1.

Table 5-1

<suffix mult>

Value	Mnemonic
1E18	EX
1E15	PE
1E12	T
1E9	G
1E6	MA
1E3	K
1E-3	M
1E-6	U
1E-9	N
1E-12	P
1E-15	F
1E-18	A

Suffix Unit The suffix units that the instrument will accept are shown in table 5-2.

Table 5-2

<suffix unit>

Suffix	Referenced Unit
V	Volt
S	Second



Status Reporting

Introduction

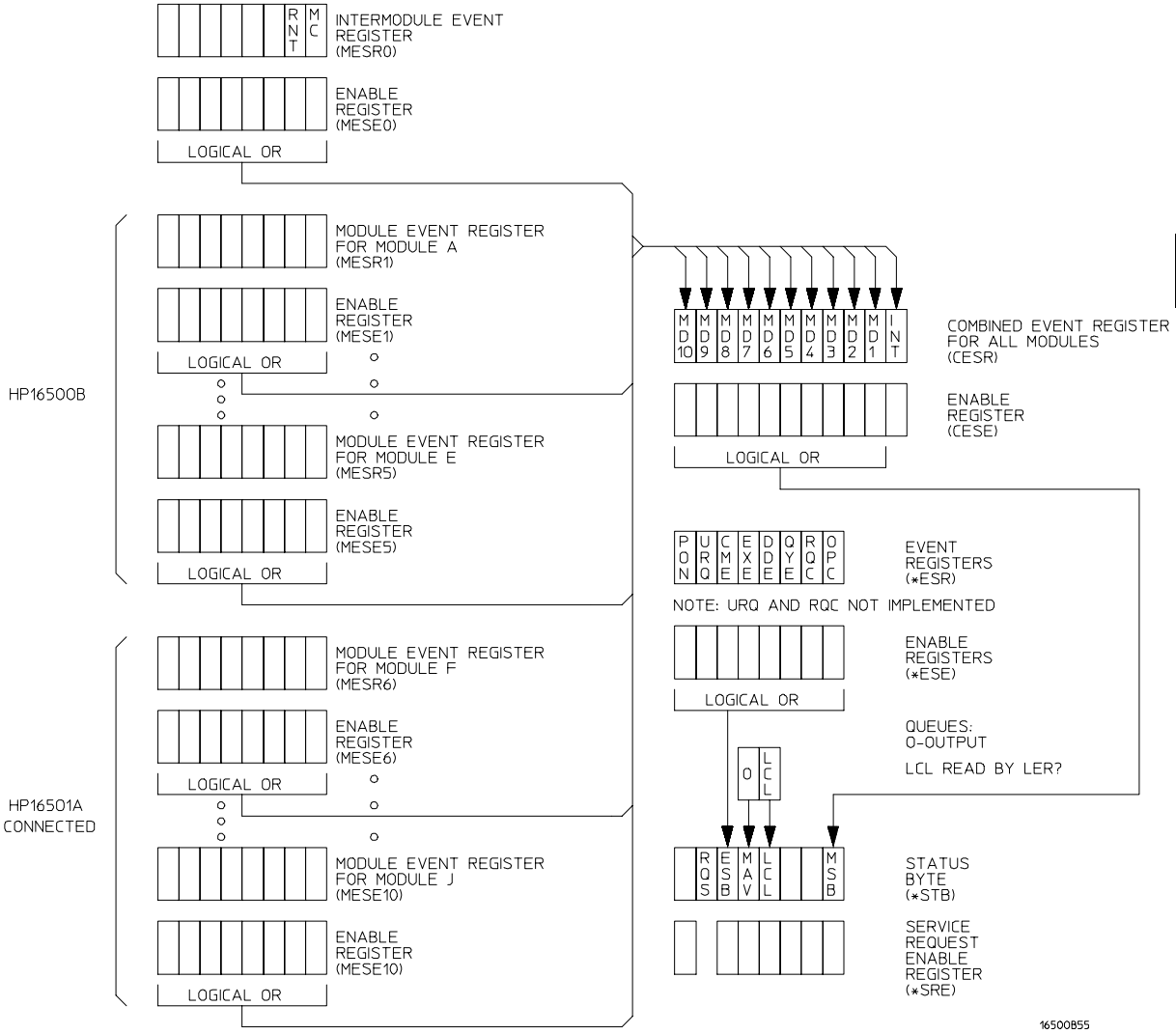
Status reporting allows you to use information about the instrument in your programs, so that you have better control of the measurement process. For example, you can use status reporting to determine when a measurement is complete, thus controlling your program, so that it does not get ahead of the instrument. This chapter describes the status registers, status bytes and status bits defined by IEEE 488.2 and discusses how they are implemented in the HP 16500B Logic Analysis System. Also in this chapter is a sample set of steps you use to perform a serial poll over HP-IB.

The status reporting features available over the bus are the serial and parallel polls. IEEE 488.2 defines data structures, commands, and common bit definitions. There are also instrument-defined structures and bits.

The bits in the status byte act as summary bits for the data structures residing behind them. In the case of queues, the summary bit is set if the queue is not empty. For registers, the summary bit is set if any enabled bit in the event register is set. The events are enabled via the corresponding event enable register. Events captured by an event register remain set until the register is read or cleared. Registers are read with their associated commands. The *CLS command clears all event registers and all queues except the output queue. If *CLS is sent immediately following a program message terminator, the output queue will also be cleared.

Figure 6-1

NOTE: THE INDIVIDUAL BIT ASSIGNMENTS FOR THE MODULE EVENT REGISTERS ARE MODULE SPECIFIC.



Status Byte Structures and Concepts

Event Status Register

The Event Status Register is an IEEE 488.2 defined register. The bits in this register are "latched." That is, once an event happens which sets a bit, that bit will only be cleared if the register is read.

Service Request Enable Register

The Service Request Enable Register is an 8-bit register. Each bit enables the corresponding bit in the status byte to cause a service request. The sixth bit does not logically exist and is always returned as a zero. To read and write to this register, use the *SRE? and *SRE commands.

Bit Definitions

The following mnemonics are used in figure 6-1 and in chapter 8, "Common Commands:"

MAV - message available

Indicates whether there is a response in the output queue.

ESB - event status bit

Indicates if any of the conditions in the Standard Event Status Register are set and enabled.

MSS - master summary status

Indicates whether the device has a reason for requesting service. This bit is returned for the *STB? query.

RQS - request service

Indicates if the device is requesting service. This bit is returned during a serial poll. RQS will be set to 0 after being read via a serial poll (MSS is not reset by *STB?).

MSG - message

Indicates whether there is a message in the message queue (Not implemented in the HP 16500B Logic Analysis System).

PON - power on

Indicates power has been turned on.

URQ - user request

Always returns a 0 from the HP 16500B Logic Analysis System.

CME - command error

Indicates whether the parser detected an error.

The error numbers and strings for CME, EXE, DDE, and QYE can be read from a device-defined queue (which is not part of IEEE 488.2) with the query :SYSTEM:ERROR?.

EXE - execution error

Indicates whether a parameter was out of range, or inconsistent with current settings.

DDE - device specific error

Indicates whether the device was unable to complete an operation for device dependent reasons.

QYE - query error

Indicates whether the protocol for queries has been violated.

RQC - request control

Always returns a 0 from the HP 16500B Logic Analysis System.

OPC - operation complete

Indicates whether the device has completed all pending operations. OPC is controlled by the *OPC common command. Because this command can appear after any other command, it serves as a general-purpose operation complete message generator.

LCL - remote to local

Indicates whether a remote to local transition has occurred.

MSB - module summary bit

Indicates that an enable event in one of the modules Status registers has occurred.

Key Features

A few of the most important features of Status Reporting are listed in the following paragraphs.

Operation Complete

The IEEE 488.2 structure provides one technique that can be used to find out if any operation is finished. The *OPC command, when sent to the instrument after the operation of interest, will set the OPC bit in the Standard Event Status Register. If the OPC bit and the RQS bit have been enabled, a service request will be generated. The commands that affect the OPC bit are the overlapped commands.

Example

```
OUTPUT XXX;"*SRE 32 ; *ESE 1" !enables an OPC service request
```

Status Byte

The Status Byte contains the basic status information which is sent over the bus in a serial poll. If the device is requesting service (RQS set), and the controller serial-polls the device, the RQS bit is cleared. The MSS (Master Summary Status) bit (read with *STB?) and other bits of the Status Byte are not be cleared by reading them. Only the RQS bit is cleared when read.

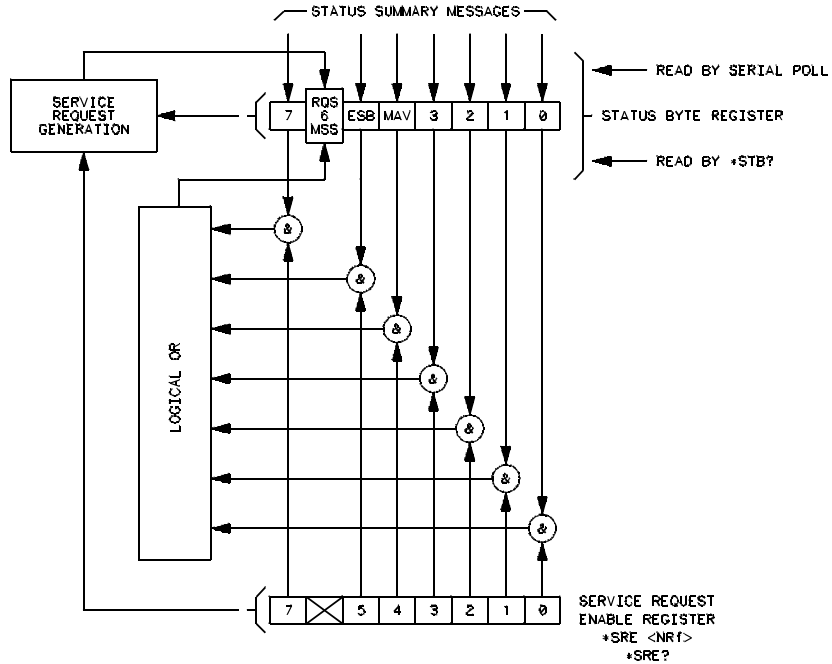
The Status Byte is cleared with the *CLS common command.

Figure 6-2.

Service Request Enabling

Serial Poll

The HP 16500B Logic Analysis System supports the IEEE 488.1 serial poll feature. When a serial poll of the instrument is requested, the RQS bit is returned on bit 6 of the status byte.



16500/BL24

Using Serial Poll (HP-IB)

This example will show how to use the service request by conducting a serial poll of all instruments on the HP-IB bus. In this example, assume that there are two instruments on the bus: the logic analysis system at address 7 and a printer at address 1.

The program command for serial poll using HP BASIC 6.2 is Stat = SPOLL(707). The address 707 is the address of the logic analysis system in this example. The command for checking the printer is Stat = SPOLL(701) because the address of that instrument is 01 on bus address 7. This command reads the contents of the HP-IB Status Register into the

variable called Stat. At that time bit 6 of the variable Stat can be tested to see if it is set (bit 6 = 1).

The serial poll operation can be conducted in the following manner:

- 1** Enable interrupts on the bus. This allows the controller to see the SRQ line.
- 2** Disable interrupts on the bus.
- 3** If the SRQ line is high (some instrument is requesting service) then check the instrument at address 1 to see if bit 6 of its status register is high.
- 4** To check whether bit 6 of an instruments status register is high, use the following BASIC statement: `IF BIT (Stat, 6) THEN`
- 5** If bit 6 of the instrument at address 1 is not high, then check the instrument at address 7 to see if bit 6 of its status register is high.
- 6** As soon as the instrument with status bit 6 high is found check the rest of the status bits to determine what is required.

The SPOLL(707) command causes much more to happen on the bus than simply reading the register. This command clears the bus automatically, addresses the talker and listener, sends SPE (serial poll enable) and SPD (serial poll disable) bus commands, and reads the data. For more information about serial poll, refer to your controller manual, and programming language reference manuals.

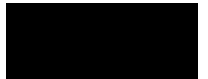
After the serial poll is completed, the RQS bit in the HP 16500B Logic Analysis System Status Byte Register will be reset if it was set. Once a bit in the Status Byte Register is set, it will remain set until the status is cleared with a *CLS command, or the instrument is reset.

Parallel Poll

Parallel poll is a controller initiated operation which is used to obtain information from several devices simultaneously. When a controller initiates a Parallel Poll, each device returns a Status Bit via one of the DIO data lines. Device DIO assignments are made by the controller using the PPC (Parallel Poll Configure) sequence. Devices respond either individually, each on a separate DIO line; collectively on a single DIO line; or any combination of these two ways. When responding collectively, the result is a logical AND (True High) or logical OR (True Low) of the groups of status bits.

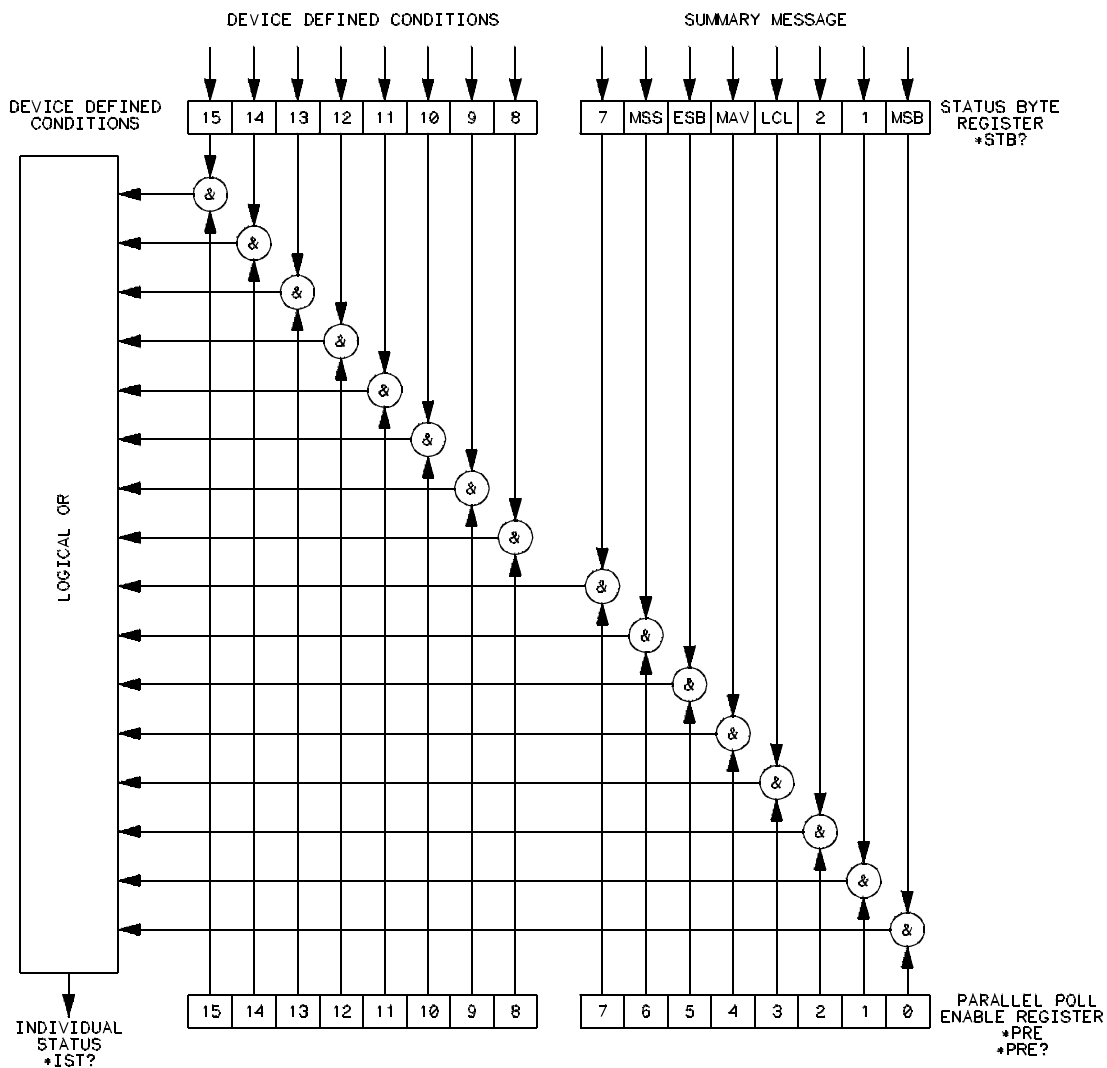
Figure 6-3 shows the Parallel Poll Data Structure. The summary bit is sent in response to a Parallel Poll. This summary bit is the "ist" (individual status) local message.

The Parallel Poll Enable Register determines which events are summarized in the ist. The `*PRE` command is used to write to the enable register and the `*PRE?` query is used to read the register. The `*IST?` query can be used to read the "ist" without doing a parallel poll.



Status Reporting
Parallel Poll

Figure 6-3



16560/BL20

Parallel Poll Data Structure

Polling HP-IB Devices

Parallel Poll is the fastest means of gathering device status when several devices are connected to the bus. Each device (with this capability) can be programmed to respond with one bit of status when parallel polled. This makes it possible to obtain the status of several devices in one operation. If a device responds affirmatively to a parallel poll, more information about its specific status can be obtained by conducting a serial poll of the device.

Configuring Parallel Poll Responses

Certain devices, including the HP 16500B Logic Analysis System, can be remotely programmed by a controller to respond to a parallel poll. A device which is currently configured for a parallel poll responds to the poll by placing its current status on one of the bus data lines. The response and the data-bit number can then be programmed by the PPC (parallel poll configure) statement. No multiple listeners can be specified in this statement. If more than one device is to respond on a single bit, each device must be configured with a separate PPC statement.

Example

```
ASSIGN @Device TO 707
PPOLL CONFIGURE @Device;Mask
```

The value of Mask (any numeric expression can be specified) is first rounded and then used to configure the device's parallel response. The least significant 3 bits (bits 0 through 2) of the expression are used to determine which data line the device is to respond on (place its status on). Bit 3 specifies the "true" state of the parallel poll response bit of the device. A value of 0 implies that the device's response is 0 when its status bit message is true.

Example

The following statement configures the device at address 07 on the interface select code 7 to respond by placing a 0 on bit 4 when its status response is "true."

```
PPOLL CONFIGURE 707;4
```

Conducting a Parallel Poll

The PPOLL (Parallel Poll) function returns a single byte containing up to 8 status bit messages for all devices on the bus capable of responding to the poll. Each bit returned by the function corresponds to the status bit of the device(s) configured to respond to the parallel poll (one or more devices can respond on a single line). The PPOLL function can only be executed by the controller. It is initiated by the simultaneous assertion of ATN and EOI.

Example

```
Response = PPOLL(7)
```

Disabling Parallel Poll Responses

The PPU (Parallel Poll Unconfigure) statement gives the controller the capability of disabling the parallel poll responses of one or more devices on the bus.

Examples

The following statement disables device 5 only:

```
PPOLL UNCONFIGURE 705
```

This statement disables all devices on interface select code 8 from responding to a parallel poll:

```
PPOLL UNCONFIGURE 8
```

If no primary address is specified, all bus devices are disabled from responding to a parallel poll. If a primary address is specified, only the specified devices (which have the parallel poll configure capability) are disabled.

HP-IB Commands

The following paragraphs describe actual HP-IB commands which can be used to perform the functions of the Basic commands shown in the previous examples.

Parallel Poll Unconfigure Command

The parallel poll unconfigure command (PPU) resets all parallel poll devices to the idle state (unable to respond to a parallel poll).

Parallel Poll Configure Command

The parallel poll configure command (PPC) causes the addressed listener to be configured according to the parallel poll enable secondary command PPE.

Parallel Poll Enable Command

The parallel poll enable secondary command (PPE) configures the devices which have received the PPC command to respond to a parallel poll on a particular HP-IB DIO line with a particular level.

Parallel Poll Disable Command

The parallel poll disable secondary command (PPD) disables the devices which have received the PPC command from responding to the parallel poll.

Table 6-1

Parallel Poll Commands

Command	Mnemonic	Decimal Code	ASCII/ISO Character
Parallel Poll Unconfigure (Multiline Command)	PPU	21	NAK
Parallel Poll Configure (Addressed Command)	PPC	05	ENQ
Parallel Poll Enable (Secondary Command)	PPE	96-111	I-O
Parallel Poll Disable (Secondary Command)	PPD	112	P



Error Messages

Introduction

This chapter lists the error messages that relate to the HP 16500B Logic Analysis System.

Device Dependent Errors

- 200 Label not found
- 201 Pattern string invalid
- 202 Qualifier invalid
- 203 Data not available
- 300 RS-232C error

Command Errors

- 100 Command error (unknown command)(generic error)
- 101 Invalid character received
- 110 Command header error
- 111 Header delimiter error
- 120 Numeric argument error
- 121 Wrong data type (numeric expected)
- 123 Numeric overflow
- 129 Missing numeric argument
- 130 Non numeric argument error (character,string, or block)
- 131 Wrong data type (character expected)
- 132 Wrong data type (string expected)
- 133 Wrong data type (block type #D required)
- 134 Data overflow (string or block too long)
- 139 Missing non numeric argument
- 142 Too many arguments
- 143 Argument delimiter error
- 144 Invalid message unit delimiter

Execution Errors

- 200 Can Not Do (generic execution error)
- 201 Not executable in Local Mode
- 202 Settings lost due to return-to-local or power on
- 203 Trigger ignored
- 211 Legal command, but settings conflict
- 212 Argument out of range
- 221 Busy doing something else
- 222 Insufficient capability or configuration
- 232 Output buffer full or overflow
- 240 Mass Memory error (generic)
- 241 Mass storage device not present
- 242 No media
- 243 Bad media
- 244 Media full
- 245 Directory full
- 246 File name not found
- 247 Duplicate file name
- 248 Media protected

Internal Errors

- 300 Device Failure (generic hardware error)
- 301 Interrupt fault
- 302 System Error
- 303 Time out
- 310 RAM error
- 311 RAM failure (hardware error)
- 312 RAM data loss (software error)
- 313 Calibration data loss

- 320 ROM error
- 321 ROM checksum
- 322 Hardware and Firmware incompatible
- 330 Power on test failed
- 340 Self Test failed
- 350 Too Many Errors (Error queue overflow)

Query Errors

- 400 Query Error (generic)
- 410 Query INTERRUPTED
- 420 Query UNTERMINATED
- 421 Query received. Indefinite block response in progress
- 422 Addressed to Talk, Nothing to Say
- 430 Query DEADLOCKED





Part 2

- 8** Common Commands 8-1
- 9** Mainframe Commands 9-1
- 10** SYSTem Subsystem 10-1
- 11** MMEMory Subsystem 11-1
- 12** INTermodule Subsystem 12-1

Commands



Common Commands

Introduction

The common commands are defined by the IEEE 488.2 standard. These commands must be supported by all instruments that comply with this standard. Refer to figure 8-1 and table 8-1 for the common commands syntax diagram.

The common commands control some of the basic instrument functions; such as, instrument identification and reset, how status is read and cleared, and how commands and queries are received and processed by the instrument. The common commands are:

- *CLS
- *ESE
- *ESR
- *IDN
- *IST
- *OPC
- *OPT
- *PRE
- *RST
- *SRE
- *STB
- *TRG
- *TST
- *WAI

Common commands can be received and processed by the HP 16500B Logic Analysis System, whether they are sent over the bus as separate program messages or within other program messages. If an instrument subsystem has been selected and a common command is received by the instrument, the system will remain in the selected subsystem.

Example

If the program message in this example is received by the system, it will initialize the disk and store the file and clear the status information. This is not the case if some other type of command is received within the program message.

```
" :MMEMORY:INITIALIZE;*CLS; STORE 'FILE ', 'DESCRIPTION' "
```

Example

This program message initializes the disk, selects the module in slot A, then stores the file. In this example, :MEMORY must be sent again in order to reenter the memory subsystem and store the file.

```
" :MEMORY:INITIALIZE;:SELECT 1;:MEMORY:STORE 'FILE ',  
'DESCRIPTION' "
```

Status Registers

Each status register has an associated status enable (mask) register. By setting the bits in the status enable register you can select the status information you wish to use. Any status bits that have not been masked (enabled in the enable register) will not be used to report status summary information to bits in other status registers.

See Also

Chapter 6, "Status Reporting," for a complete discussion of how to read the status registers and how to use the status information available from this instrument.


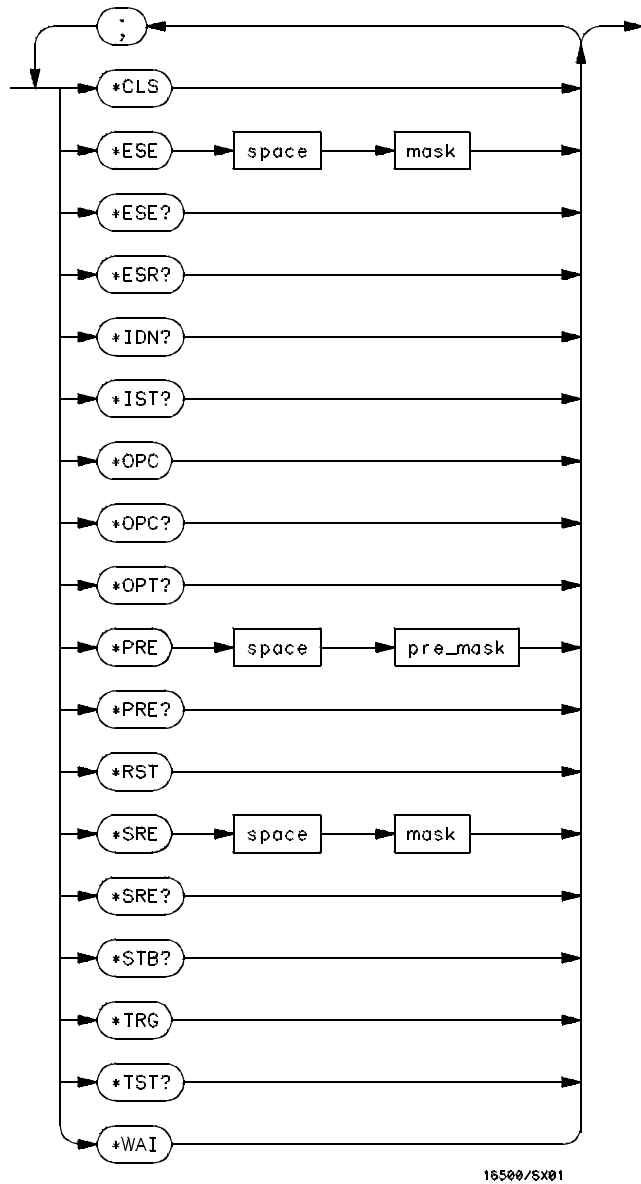


Figure 8-1



Common Commands Syntax Diagram

Table 8-1

Common Command Parameter Values

Parameter	Values
mask	An integer, 0 through 255.
pre_mask	An integer, 0 through 65535.

***CLS (Clear Status)**

Command

*CLS

The *CLS common command clears all event status registers, queues, and data structures, including the device defined error queue and status byte. If the *CLS command immediately follows a program message terminator, the output queue and the MAV (Message Available) bit will be cleared.

Example

OUTPUT XXX; " *CLS "

See Also

Refer to chapter 6, "Status Reporting," for a complete discussion of status.

***ESE (Event Status Enable)**

Command *ESE <mask>

The *ESE command sets the Standard Event Status Enable Register bits. The Standard Event Status Enable Register contains a bit to enable the status indicators detailed in table 8-2. A 1 in any bit position of the Standard Event Status Enable Register enables the corresponding status in the Standard Event Status Enable Register.

<mask> An integer from 0 to 255

Example

In this example, the *ESE 32 command will enable CME (Command Error), bit 5 of the Standard Event Status Enable Register. Therefore, when a command error occurs, the event summary bit (ESB) in the Status Byte Register will also be set.

OUTPUT XXX; "*ESE 32"

Query *ESE?

The *ESE query returns the current contents of the enable register.

Returned Format <mask><NL>

Example

OUTPUT XXX; "*ESE?"

See Also

Refer to Chapter 6, "Status Reporting" for a complete discussion of status.

Table 8-2

Standard Event Status Enable Register

Bit Position	Bit Weight	Enables
7	128	PON - Power On
6	64	URQ - User Request
5	32	CME - Command Error
4	16	EXE - Execution Error
3	8	DDE - Device Dependent Error
2	4	QYE - Query Error
1	2	RQC - Request Control
0	1	OPC - Operation Complete

***ESR (Event Status Register)**

Query

*ESR?

The *ESR query returns the contents of the Standard Event Status Register. Reading the register clears the Standard Event Status Register.

Returned Format

<status><NL>

<status> An integer from 0 to 255

Example

If a command error has occurred, and bit 5 of the ESE register is set, the string variable Esr_event\$ will have bit 5 (the CME bit) set.

```
10 OUTPUT XXX;"*ESE 32           !Enables bit 5 of the status register
20 OUTPUT XXX;"*ESR?"           !Queries the status register
30 ENTER XXX; Esr_event$        !Reads the query buffer
```

Table 8-3 shows the Standard Event Status Register. The table details the meaning of each bit position in the Standard Event Status Register and the bit weight. When you read Standard Event Status Register, the value returned is the total bit weight of all the bits that are high at the time you read the byte.

Table 8-3

The Standard Event Status Register

Bit Position	Bit Weight	Bit Name	Condition
7	128	PON	0 = register read - not in power up mode 1 = power up
6	64	URQ	0 = user request - not used - always zero
5	32	CME	0 = no command errors 1 = a command error has been detected
4	16	EXE	0 = no execution errors 1 = an execution error has been detected
3	8	DDE	0 = no device dependent error has been detected 1 = a device dependent error has been detected
2	4	QYE	0 = no query errors 1 = a query error has been detected
1	2	RQC	0 = request control - not used - always zero
0	1	OPC	0 = operation is not complete 1 = operation is complete

*IDN (Identification Number)

Query

* IDN?

The *IDN? query allows the instrument to identify itself. It returns the string:

```
"HEWLETT-PACKARD,16500B,0,REV <revision_code> "
```

An *IDN? query must be the last query in a message. Any queries after the *IDN? in the program message are ignored.

Returned Format

```
HEWLETT-PACKARD,16500B,0,REV <revision code>
```

<revision
code>

Four digit-code in the format XX.XX representing the current ROM revision.

Example

```
OUTPUT XXX; " *IDN? "
```

*IST (Individual Status)

Query

* IST?

The *IST query allows the instrument to identify itself during parallel poll by allowing the controller to read the current state of the IEEE 488.1 defined "ist" local message in the instrument. The response to this query is dependent upon the current status of the instrument.

Figure 8-2 shows the *IST data structure.

Returned Format

```
<id><NL>
```

<id> 0 or 1

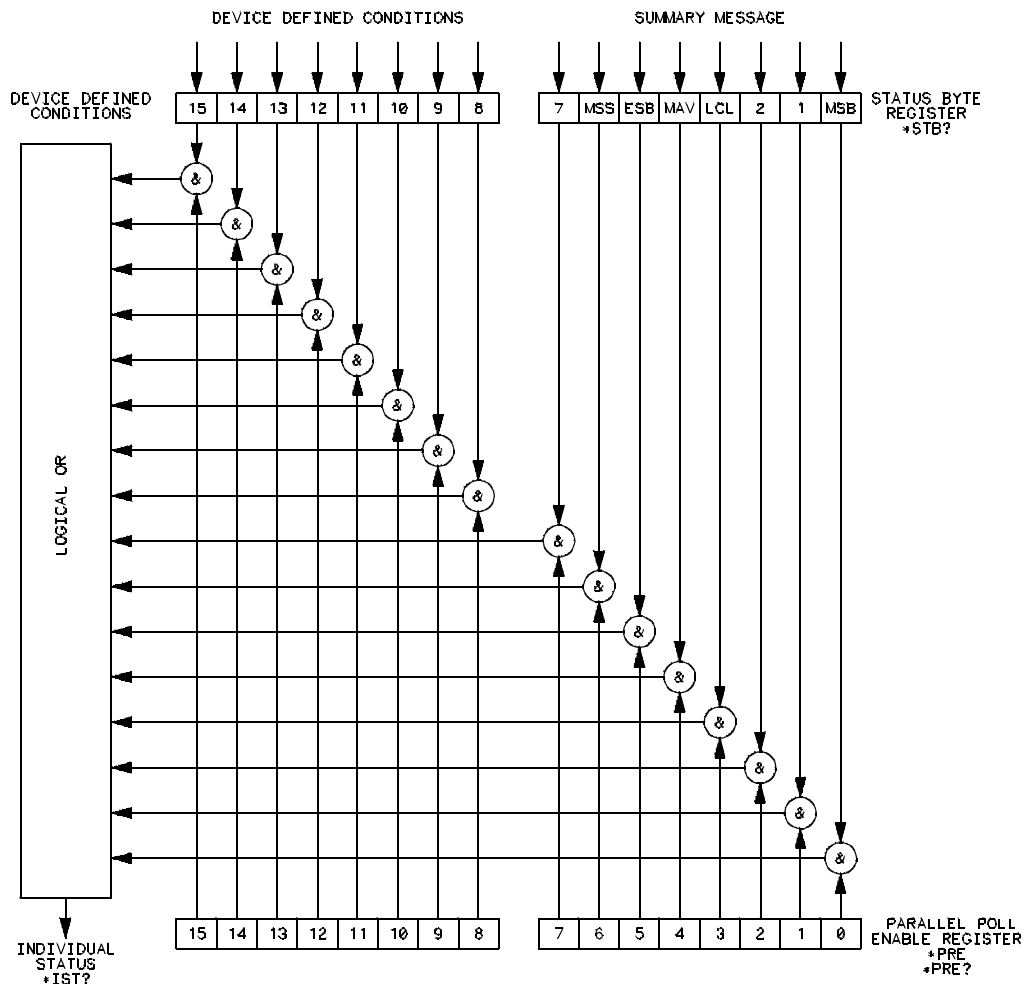
- 1 Indicates the "ist" local message is false.
- 0 Indicates the "ist" local message is true.

Common Commands
***IST (Individual Status)**

Example

OUTPUT XXX; "*IST?"

Figure 8-2



16500/BL20

***IST Data Structure**

*OPC (Operation Complete)

Command

*OPC

The *OPC command will cause the instrument to set the operation complete bit in the Standard Event Status Register when all pending device operations have finished. The commands which affect this bit are the overlapped commands. An overlapped command is a command that allows execution of subsequent commands while the device operations initiated by the overlapped command are still in progress. The overlapped commands for the HP 16500B are START and STOP.

Example

OUTPUT XXX; "*OPC"

Query

*OPC?

The *OPC query places an ASCII "1" in the output queue when all pending device operations have been completed.

Returned Format

1<NL>

Example

OUTPUT XXX; "*OPC?"

*OPT (Option Identification)

Query

*OPT?

The *OPT query identifies the software installed in the HP 16500B. This query returns nine parameters. The first parameter indicates whether you are in the System. The next two parameters indicate any software options installed, and the next parameter indicates whether intermodule is available for the System. The last five parameters list the installed software for the modules in slot A through E for an HP 16500B mainframe. When an HP 16501A Expansion frame is connected, there will be ten parameters after the INTERMODULE for modules in slots A through J. A zero in any of the last eight parameters indicates that the corresponding software is not currently installed.

Returned Format

{SYSTEM}, {<option>|0}, {<option>|0}, {INTERMODULE|0}, {<module>|0},
{<module>|0}, {<module>|0}, {<module>|0}, {<module>|0},
[, {<module>|0}, {<module>|0}, {<module>|0}, {<module>|0},
{<module>|0}]<NL>

<option> Name of software option

<module> Name of module software

Example

OUTPUT XXX; " *OPT? "

***PRE (Parallel Poll Enable Register Enable)**

Command *PRE <mask>

The *PRE command sets the parallel poll register enable bits. The Parallel Poll Enable Register contains a mask value that is ANDed with the bits in the Status Bit Register to enable an "ist" during a parallel poll. Refer to table 8-4 for the bits in the Parallel Poll Enable Register and for what they mask.

<pre_mask> An integer from 0 to 65535.

Example

This example will allow the HP 16500B to generate an "ist" when a message is available in the output queue. When a message is available, the MAV (Message Available) bit in the Status Byte Register will be high.

OUTPUT XXX; "*PRE 16"

Query *PRE?

The *PRE? query returns the current value of the register.

Returned format <mask><NL>

<mask> An integer from 0 through 65535 representing the sum of all bits that are set. .

Example

OUTPUT XXX; "*PRE?"

See Also

Chapter 6, "Parallel Poll," for more informaion on how to conduct a parallel poll.

Table 8-4

HP 16500B Parallel Poll Enable Register

Bit Position	Bit Weight	Enables
15-8		Not used
7	128	Not used
6	64	MSS - Master Summary Status
5	32	ESB - Event Status
4	16	MAV - Message Available
3	8	LCL - Local
2	4	Not used
1	2	Not used
0	1	MSB - Module Summary

***RST (Reset)**

The *RST command is not implemented on the HP 16500B. The HP 16500B will accept this command, but the command has no affect on the system.

The *RST command is generally used to place the system in a predefined state. Because the HP 16500B allows you to store predefined configuration files for individual modules, or for the entire system, resetting the system can be accomplished by simply loading the appropriate configuration file.

See Also

For more information, refer to chapter 11, "MMEMory Subsystem."

***SRE (Service Request Enable)**

Command *SRE <mask>

The *SRE command sets the Service Request Enable Register bits. The Service Request Enable Register contains a mask value for the bits to be enabled in the Status Byte Register. A one in the Service Request Enable Register will enable the corresponding bit in the Status Byte Register. A zero will disable the bit. Refer to table 8-5 for the bits in the Service Request Enable Register and what they mask.

<mask> An integer from 0 to 255

Example

This example enables a service request to be generated when a message is available in the output queue. When a message is available, the MAV (Message Available) bit will be high.

OUTPUT XXX; " *SRE 16 "

Query

*SRE?

Returned Format

The *SRE query returns the current value.

<mask><NL>

<mask> An integer from 0 to 255 representing the sum of all bits that are set.

Example

OUTPUT XXX; " *SRE? "

See Also

Refer to Chapter 6, "Status Reporting," for a complete discussion of status.

Table 8-5

HP 16500B Service Request Enable Register

Bit Position	Bit Weight	Enables
15-8		not used
7	128	not used
6	64	MSS - Master Summary Status (always 0)
5	32	ESB - Event Status
4	16	MAV - Message Available
3	8	LCL- Local
2	4	not used
1	2	not used
0	1	MSB - Module Summary

***STB (Status Byte)**

 Query

*STB?

The *STB query returns the current value of the instrument's status byte. The MSS (Master Summary Status) bit, and, not the RQS (Request Service) bit is reported on bit 6. The MSS indicates whether or not the device has at least one reason for requesting service. Refer to table 8-6 for the meaning of the bits in the status byte.

Returned Format

<value><NL>

<value> An integer from 0 through 255

Example

OUTPUT XXX; "*STB?"

See Also

Refer to Chapter 6, "Status Reporting" for a complete discussion of status.

Table 8-6

The Status Byte Register

Bit Position	Bit Weight	Bit Name	Condition
7	128		0 = not Used
6	64	MSS	0 = instrument has no reason for service 1 = instrument is requesting service
5	32	ESB	0 = no event status conditions have occurred 1 = an enabled event status condition has occurred
4	16	MAV	0 = no output messages are ready 1 = an output message is ready
3	8	LCL	0 = a remote-to-local transition has not occurred 1 = a remote-to-local transition has occurred
2	4		not used
1	2		not used
0	1	MSB	0 = a module or the system has activity to report 1 = no activity to report

0 = False = Low
 1 = True = High



***TRG (Trigger)**

Command

*TRG

The *TRG command has the same effect as a Group Execute Trigger (GET). That effect is as if the START command had been sent for intermodule group run. If no modules are configured in the Intermodule menu, this command has no effect.

Example

OUTPUT XXX; "*TRG"

***TST (Test)**

Query

*TST?

The *TST query returns the results of the power-up self-test. The result of that test is a 9-bit mapped value which is placed in the output queue. A one in the corresponding bit means that the test failed and a zero in the corresponding bit means that the test passed. Refer to table 8-7 for the meaning of the bits returned by a TST? query.

Returned Format

<result><NL>

<result> An integer 0 through 511

Example

```
10 OUTPUT XXX;"*TST?"
20 ENTER XXX;Tst_value
```

Table 8-7

Bits Returned by *TST? Query (Power-Up Test Results)

Bit Position	Bit Weight	Test
8	256	Disk Test
7	128	not used
6	64	not used
5	32	Front-panel Test
4	16	HIL Test
3	8	Display Test
2	4	Interrupt Test
1	2	RAM Test
0	1	ROM Test

***WAI (Wait)**

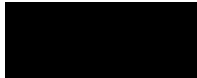
Command

***WAI**

The ***WAI** command causes the device to wait until completing all of the overlapped commands before executing any further commands or queries. An overlapped command is a command that allows execution of subsequent commands while the device operations initiated by the overlapped command are still in progress. Some examples of overlapped commands for the HP 16500B are **START** and **STOP**.

Example:

OUTPUT XXX; "***WAI**"







Mainframe Commands

Introduction

Mainframe commands control the basic operation of the instrument for both the HP 16500B mainframe alone or with the HP 16501A expansion frame connected. Mainframe commands can be called at anytime, and from any module. The only difference in mainframe commands with an HP 16501A connected is the number of slots and modules. These differences will be noted in the affected command descriptions.

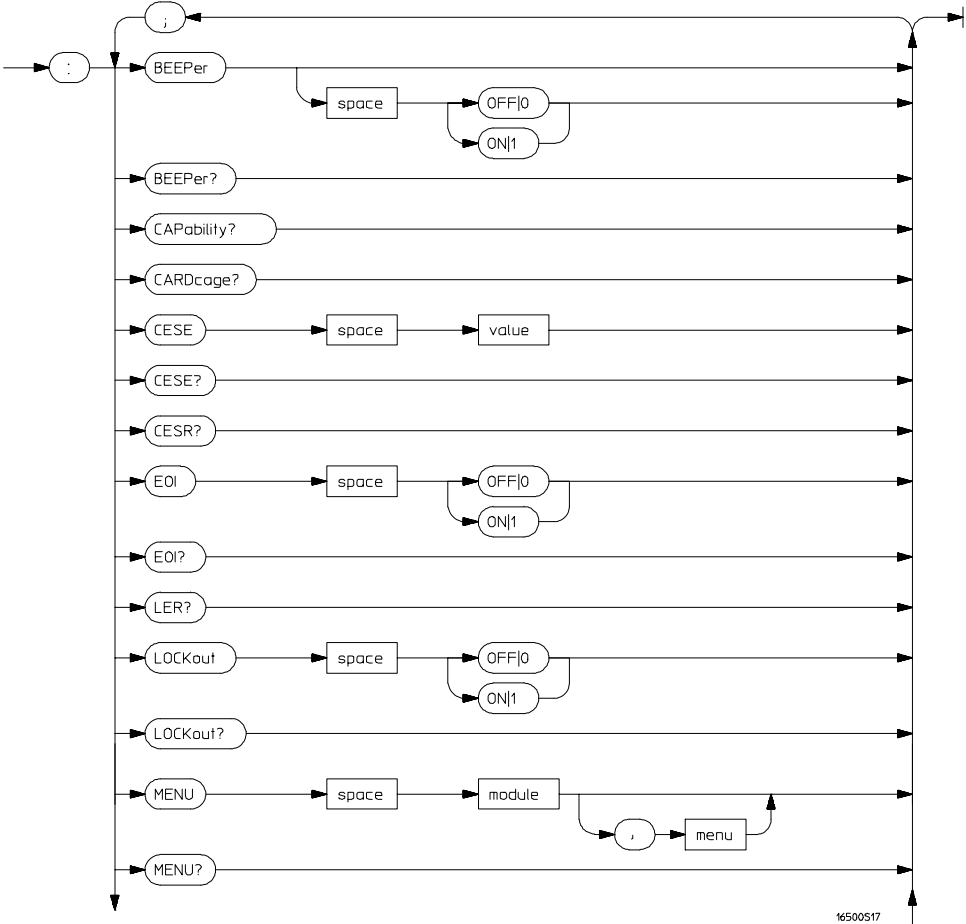
The main difference between an HP 16500B alone and an HP 16500B with the HP 16501A connected is how you specify the `SELECT` command. Remember, the HP 16500B alone has only five slots; therefore, if you specify 6 through 10 for the `SELECT` command in your program, the command parser will take no action.

This chapter contains the mainframe commands with a syntax example for each command. Each syntax example contains the parameters for the HP 16500B/16501A. Refer to figure 9-1 and table 9-1 for the Mainframe commands syntax diagram.

The mainframe commands are:

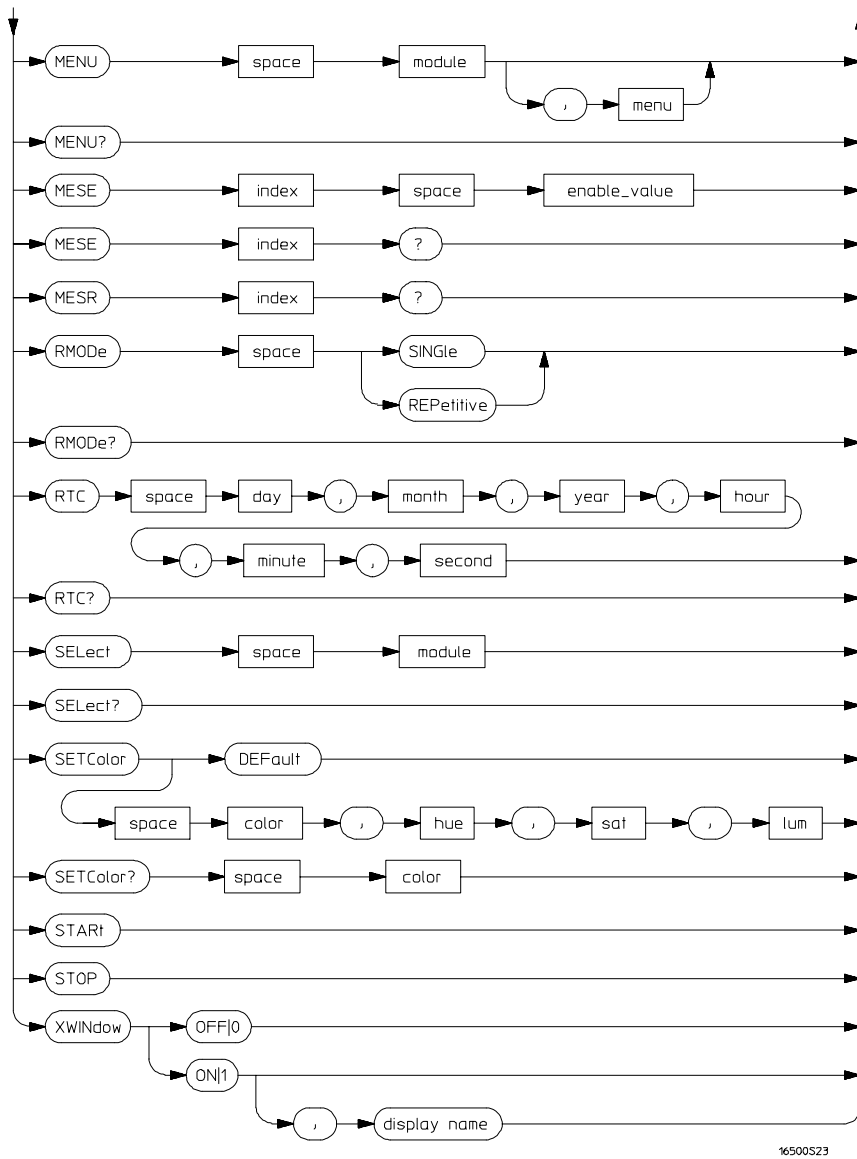
- BEEPer
- CAPability
- CARDcage
- CESE
- CESR
- EOI
- LER
- LOCKout
- MENU
- MESE
- MESR
- RMODe
- RTC
- SElect
- SETColor
- START
- STOP
- XWINdow

Figure 9-1



Mainframe Commands Syntax Diagram

Figure 9-1 (continued)

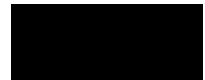


Mainframe Commands Syntax Diagram (continued)

Table 9-1

Mainframe Parameter Values

Parameter	Values
value	An integer from 0 to 65535.
module	An integer from -2 through 5 for an HP 16500B alone or from -2 through 10 with an HP 16501A connected.
menu	An integer.
enable_value	An integer from 0 to 255.
index	An integer from 0 to 5.
day	An integer from 1 through 31
month	An integer from 1 through 12
year	An integer from 1990 through 2089
hour	An integer from 0 through 23
minute	An integer from 0 through 59
second	An integer from 0 through 59
color	An integer from 1 to 7.
hue	An integer from 0 to 100.
sat	An integer from 0 to 100.
lum	An integer from 0 to 100.
display name	A string containing an Internet Address and a display name, for example, "12.3.19.1:0.0".



BEEPer

Command : BEEPer [{ON|1} | {OFF|0}]

The BEEPer command sets the beeper mode, which turns the beeper sound of the instrument on and off. When BEEPer is sent with no argument, the beeper will be sounded without affecting the current mode.

Example

OUTPUT XXX; ":BEEPER"
OUTPUT XXX; ":BEEP ON"

Query : BEEPer?

The BEEPer? query returns the mode currently selected.

Returned Format [:BEEPer] {1|0} <NL>

Example

OUTPUT XXX; ":BEEPER?"

CAPability

Query :CAPability?

The CAPability query returns the IEEE 488.1 "Interface Requirements for Devices" capability sets implemented in the device.

Table 9-2 lists the capability sets implemented in the HP 16500B.

Returned Format [:CAPability] IEEE488,1987,SH1,AH1,T5,L4,SR1,RL1,PP1,DC1,DT1,C0,E2<NL>

Example OUTPUT XXX; " :CAPABILITY?"

Table 9-2 HP 16500B Capability Sets

Mnemonic	Capability Name	Implementation
SH	Source Handshake	SH1
AH	Acceptor Handshake	AH1
T	Talker (or TE - Extended Talker)	T5
L	Listener (or LE - Extended Listener)	L4
SR	Service Request	SR1
RL	Remote Local	RL1
PP	Parallel Poll	PP1
DC	Device Clear	DC1
DT	Device Trigger	DT1
C	Any Controller	C0
E	Electrical Characteristic	E2

CARDcage

Query : CARDcage?

The CARDcage query returns a series of integers which identifies the modules that are installed in the mainframe. For an HP 16500B alone, the first five numbers returned are the card identification numbers (a -1 means no card is in the slot). The remaining five numbers returned indicate the module assignment for each card. The possible values for the module assignment are 0, 1, 2, 3, 4, and 5 where 0 indicates an empty slot or the module software is not recognized or not loaded. 1..5 indicates the number of the slot in which the master card for this card is located.

When an HP 16501A is connected, the first ten numbers returned are the card identification numbers (a -1 means no card is in the slot). The remaining ten numbers returned indicate the module assignment for each card. The possible values for the module assignment are 0 through 10 where 0 indicates an empty slot or the module software is not recognized or not loaded. 1...10 indicates the number of the slot in which the master card for this card is located.

Table 9-2 lists the card identification numbers for the first five parameters and their associated cards.

[:CARDcage]
<ID>, <ID>, <ID>, <ID>, <ID>, [<ID>, <ID>, <ID>, <ID>, <ID>,]
<assign>, <assign>, <assign>, <assign>, <assign>
[,<assign>, <assign>, <assign>, <assign>, <assign>]<NL>

<ID> An integer indicating the card identification number.

<assign> An integer indicating the module assignment.

Example

OUTPUT XXX; " : CARDCAGE? "

Table 9-2**Card Identification Numbers**

Id Number	Card
1	HP 16515A 1 GHz Timing Master Card
2	HP 16516A 1 GHz Timing Expansion Card
11	HP 16530A Oscilloscope Timebase Card
12	HP 16531A Oscilloscope Acquisition Card
13	HP 16532A Oscilloscope Card
21	HP 16520A Pattern Generator Master Card
22	HP 16521A Pattern Generator Expansion Card
30	HP 16511B Logic Analyzer Cards
31	HP 16510A or B Logic Analyzer Card
32	HP 16550A Logic Analyzer Master Card
33	HP 16550A Logic Analyzer Expansion Card
40	HP 16540A Logic Analyzer Card
41	HP 16541A Logic Analyzer Card
42	HP 16542A Logic Analyzer Master Card
43	HP 16542A Logic Analyzer Expansion Card



CESE (Combined Event Status Enable)

Command :CESE <value>

The CESE command sets the Combined Event Status Enable register. This register is the enable register for the CESR register and contains the combined status of all of the MESE (Module Event Status Enable) registers of the HP 16500B. Table 9-3 lists the bit values for the CESE register.

<value> An integer from 0 to 65535

Example OUTPUT XXX; ":CESE 32"

Query :CESE?

The CESE? query returns the current setting.

Returned Format [:CESE] <value><NL>

Example OUTPUT XXX; ":CESE?"

Table 9-3

HP 16500B Combined Event Status Enable Register

Bit	Weight	Enables
11-15		not used
10	1024	Module in slot J
9	512	Module in slot I
8	256	Module in slot H
7	128	Module in slot G
6	64	Module in slot F
5	32	Module in slot E
4	16	Module in slot D
3	8	Module in slot C
2	4	Module in slot B
1	2	Module in slot A
0	1	Intermodule

CESR (Combined Event Status Register)

Query

:CESR?

The CESR query returns the contents of the Combined Event Status register. This register contains the combined status of all of the MESRs (Module Event Status Registers) of the HP 16500B System. Table 9-4 lists the bit values for the CESR register.

Returned Format

[:CESR] <value><NL>

<value> An integer from 0 to 65535

Example

OUTPUT XXX; " :CESR? "

Table 9-4

HP 16500B Combined Event Status Register

Bit	Bit Weight	Bit Name	Condition
11-15			0 = not used
10	1024	Module J	0 = No new status 1 = Status to report
9	512	Module I	0 = No new status 1 = Status to report
8	256	Module H	0 = No new status 1 = Status to report
7	128	Module G	0 = No new status 1 = Status to report
6	64	Module F	0 = No new status 1 = Status to report
5	32	Module E	0 = No new status 1 = Status to report
4	16	Module D	0 = No new status 1 = Status to report
3	8	Module C	0 = No new status 1 = Status to report
2	4	Module B	0 = No new status 1 = Status to report
1	2	Module A	0 = No new status 1 = Status to report
0	1	Intermodule	0 = No new status 1 = Status to report

EOI (End Or Identify)

Command :EOI {{ON|1}}|{{OFF|0}}

The EOI command specifies whether or not the last byte of a reply from the instrument is to be sent with the EOI bus control line set true or not. If EOI is turned off, the logic analyzer will no longer be sending IEEE 488.2 compliant responses.

Example OUTPUT XXX; ":EOI ON"

Query :EOI?

The EOI? query returns the current status of EOI.

Returned Format [:EOI] {1|0}<NL>

Example OUTPUT XXX; ":EOI?"

LER (LCL Event Register)

Query :LER?

The LER query allows the LCL Event Register to be read. After the LCL Event Register is read, it is cleared. A one indicates a remote-to-local transition has taken place. A zero indicates a remote-to-local transition has not taken place.

Returned Format [:LER] {0|1}<NL>

Example

OUTPUT XXX; ":LER?"

LOCKout

Command

:LOCKout {{ON|1}|{OFF|0}}

The LOCKout command locks out or restores front panel operation. When this function is on, all controls (except the power switch) are entirely locked out.

Example

OUTPUT XXX; ":LOCKOUT ON"

Query

:LOCKout?

The LOCKout query returns the current status of the LOCKout command.

Returned Format

[:LOCKout] {0|1}<NL>

Example

OUTPUT XXX; ":LOCKOUT?"

MENU

Command :MENU <module>[,<menu>]

The MENU command puts a menu on the display. The first parameter specifies the desired module. The optional second parameter specifies the desired menu in the module (defaults to 0). Table 9-5 lists the module parameters. The mainframe menus and their parameters are listed in table 9-6.

<module> Selects module or system. An integer from -2 through 5 for HP 16500B only or an integer from -2 through 10 with an HP 16501A connected.

<menu> Selects menu (integer)

Example

OUTPUT XXX; " :MENU 0,1 "

Table 9-5**First Parameter Values**

Parameter	Menu
0	System/Intermodule
1	Module in slot A
2	Module in slot B
3	Module in slot C
4	Module in slot D
5	Module in slot E
-1	Software option 1
-2	Software option 2
Available when an HP 16501A is connected:	
6	Module in slot F
7	Module in slot G
8	Module in slot H
9	Module in slot I
10	Module in slot J

Table 9-6

System Menu Values

Menu Command Parameters	Menu
MENU 0,0	System Configuration menu
MENU 0,1	Hard disk menu
MENU 0,2	Flexible disk menu
MENU 0,3	Utilities menu
MENU 0,4	Test menu
MENU 0,5	Intermodule menu

Query :MENU?

The MENU query returns the current menu selection.

Returned Format [:MENU] <module> , <menu><NL>

Example

OUTPUT XXX; " :MENU?"

MESE<N> (Module Event Status Enable)

Command :MESE<N> <enable_value>

The MESE command sets the Module Event Status Enable register. This register is the enable register for the MESR register. The <N> index specifies the module, and the parameter specifies the enable value. For the HP 16500B alone, the <N> index 0 through 5 refers to system and modules 1 through 5 respectively. With an HP 16501A connected, the <N> index 6 through 10 refers to modules 6 through 10 respectively. Table 9-7 lists the Module Event Status Enable register bits, bit weights, and what each bit masks for the mainframe.

<N> An integer 0 through 10

<enable_value> An integer from 0 through 255

Example

OUTPUT XXX; " :MESE1 3"

Query : MESE<N>?

The query returns the current setting. Table 9-7 lists the Module Event Status Enable register bits, bit weights, and what each bit masks for the mainframe.

Returned Format [:MESE<N>] <enable_value><NL>

Example OUTPUT XXX; " :MESE1? "

Table 9-7 HP 16500B Mainframe (Intermodule) Module Event Status Enable Register

Bit Position	Bit Weight	Enables
7	128	not used
6	84	not used
5	32	not used
4	16	not used
3	8	not used
2	4	not used
1	2	RNT - Intermodule Run Until Satisfied
0	1	MC - Intermodule Measurement Complete



MESR<N> (Module Event Status Register)

Query :MESR<N>?

The MESR query returns the contents of the Module Event Status register. The <N> index specifies the module. For the HP 16500B alone, the <N> index 0 through 5 refers to system and modules 1 through 5 respectively. With an HP 16501A connected, the <N> index 6 through 10 refers to modules 6 through 10 respectively.

Refer to table 9-8 for information about the Module Event Status Register bits and their bit weights.

Returned Format [:MESR<N>] <enable_value><NL>

<N> An integer 0 through 1.

<enable_value> An integer from 0 through 255

Example

OUTPUT XXX; " :MESR1? "

Table 9-8

HP 16500B Mainframe Module Event Status Register

Bit	Bit Weight	Bit Name	Condition
7	128		0 = not used
6	64		0 = not used
5	32		0 = not used
4	16		0 = not used
3	8		0 = not used
2	4		0 = not used
1	2	RNT	0 = Intermodule Run until not satisfied 1 = Intermodule Run until satisfied
0	1	MC	0 = Intermodule Measurement not satisfied 1 = Intermodule Measurement satisfied

RMODe

Command :RMODe {SINGle|REPetitive}

The RMODe command specifies the run mode for the selected module (or Intermodule). If the selected module is in the intermodule configuration, then the intermodule run mode will be set by this command.

After specifying the run mode, use the START command to start the acquisition.

Example

OUTPUT XXX; ":RMODE SINGLE "

Query

:RMODe?

Returned Format

The query returns the current setting.
[:RMODe] {SINGle|REPetitive}<NL>

Example

OUTPUT XXX; ":RMODE? "

RTC (Real-time Clock)

Command :RTC <day> , <month> , <year> , <hour> , <minute> , <second>

The real-time clock command allows you to set the real-time clock to the current date and time.

<day> integer from 1 to 31
<month> integer from 1 to 12
<year> integer from 1990 to 2089
<hour> integer from 0 to 23
<minute> integer from 0 to 59
<second> integer from 0 to 59

Example

This example sets the real-time clock for 1 January 1992, 20:00:00 (8 PM).

OUTPUT XXX; " :RTC 1,1,1992,20,0,0"

Query :RTC?

The RTC query returns the real-time clock setting.

Returned Format [:RTC] <day> , <month> , <year> , <hour> , <minute> , <second>

Example

OUTPUT XXX; " :RTC? "

SElect

Command :SElect <module>

The SElect command selects which module (or system) will have parser control. The appropriate module (or system) must be selected before any module (or system) specific commands can be sent. SELECT 0 selects System, SELECT 1 through 5 selects modules A through E in an HP 16500B only. SELECT 1 through 10 selects modules A through J when an HP 16501A is connected. -1 and -2 selects software options 1 and 2 respectively. The query returns the current module selection.

When a module is selected, the parser recognizes the module's commands and the System/Intermodule commands. When SELECT 0 is used, only the System/Intermodule commands are recognized by the parser. Figure 9-2 shows the command tree for the SElect command.

<module> Selects module or system. An integer from -2 through 5 for HP 16500B only or an integer from -2 through 10 with an HP 16501A connected.

Example

OUTPUT XXX; " :SELECT 0 "

Query

:SElect?

The SElect? query returns the current module selection.

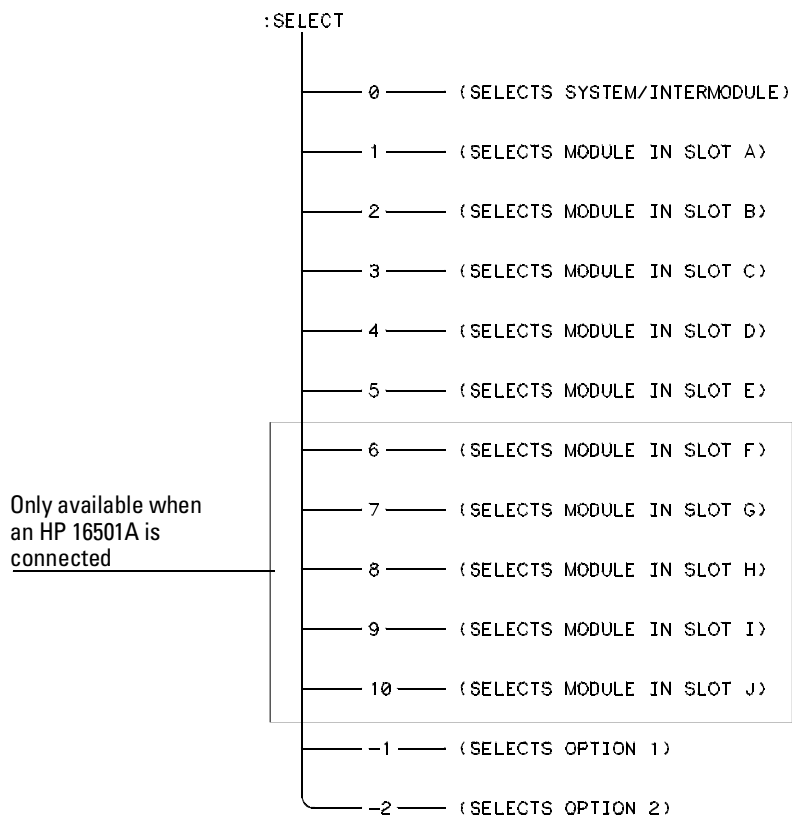
Returned Format

[:SElect] <module><NL>

Example

OUTPUT XXX; " :SELECT? "

Figure 9-2



16500847

Select Command Tree

SETColor

Command :SETColor {<color>,<hue>,<sat>,<lum>|Default}

The SETColor command is used to change one of the color selections on the CRT, or to return to the default screen colors. Four parameters are sent with the command to change a color:

- Color Number (first parameter)
- Hue (second parameter)
- Saturation (third parameter)
- Luminosity (last parameter)

<color> An integer from 1 to 7

<hue> An integer from 0 to 100

<sat> An integer from 0 to 100

<lum> An integer from 0 to 100

Color Number 0 cannot be changed.

Example

```
OUTPUT XXX; ":SETCOLOR 3,60,100,60"  
OUTPUT XXX; ":SETC DEFAULT"
```

STARt

Query :SETColor? <color>

The SETColor query returns the hue, saturation, and luminosity values for a specified color.

Returned Format [:SETColor] <color>,<hue>,<sat>,<lum><NL>

Example OUTPUT XXX; ":SETCOLOR? 3"

STARt

Command : STARt

The STARt command starts the selected module (or Intermodule) running in the specified run mode (see RMODe). If the specified module is in the Intermodule configuration, then the Intermodule run will be started.

The STARt command is an overlapped command. An overlapped command is a command that allows execution of subsequent commands while the device operations initiated by the overlapped command are still in progress.

Example OUTPUT XXX; ":STARt"

STOP

Command : STOP

The STOP command stops the selected module (or Intermodule). If the specified module is in the Intermodule configuration, then the Intermodule run will be stopped.

The STOP command is an overlapped command. An overlapped command is a command that allows execution of subsequent commands while the device operations initiated by the overlapped command are still in progress.

Example

OUTPUT XXX; " : STOP "

XWINDow

Command : XWINDow {OFF|0}
 : XWINDow {ON|1}[,<display name>]

The XWINDow command opens or closes a window on an X Window display server, that is, a networked workstation or personal computer. The XWINDow ON command opens a window. If no display name is specified, the display name already stored in the HP 16500B X Window configuration menu is used. If a display name is specified, that name is used. The specified display name also is stored in non-volatile memory in the HP 16500B.

<display name> A string containing an Internet (IP) Address optionally followed by a display and screen specifier. For example,
 "12.3.47.11"
 or
 "12.3.47.11:0.0"

Examples

To open a window, specifying and storing the display name:

```
OUTPUT XXX;":XWINDOW ON,'12.3.47.11' "
```

To open a window, using the stored display name:

```
OUTPUT XXX;":XWINDOW ON"
```

To close the X Window:

```
OUTPUT XXX;":XWINDOW OFF"
```



SYSTEM Subsystem

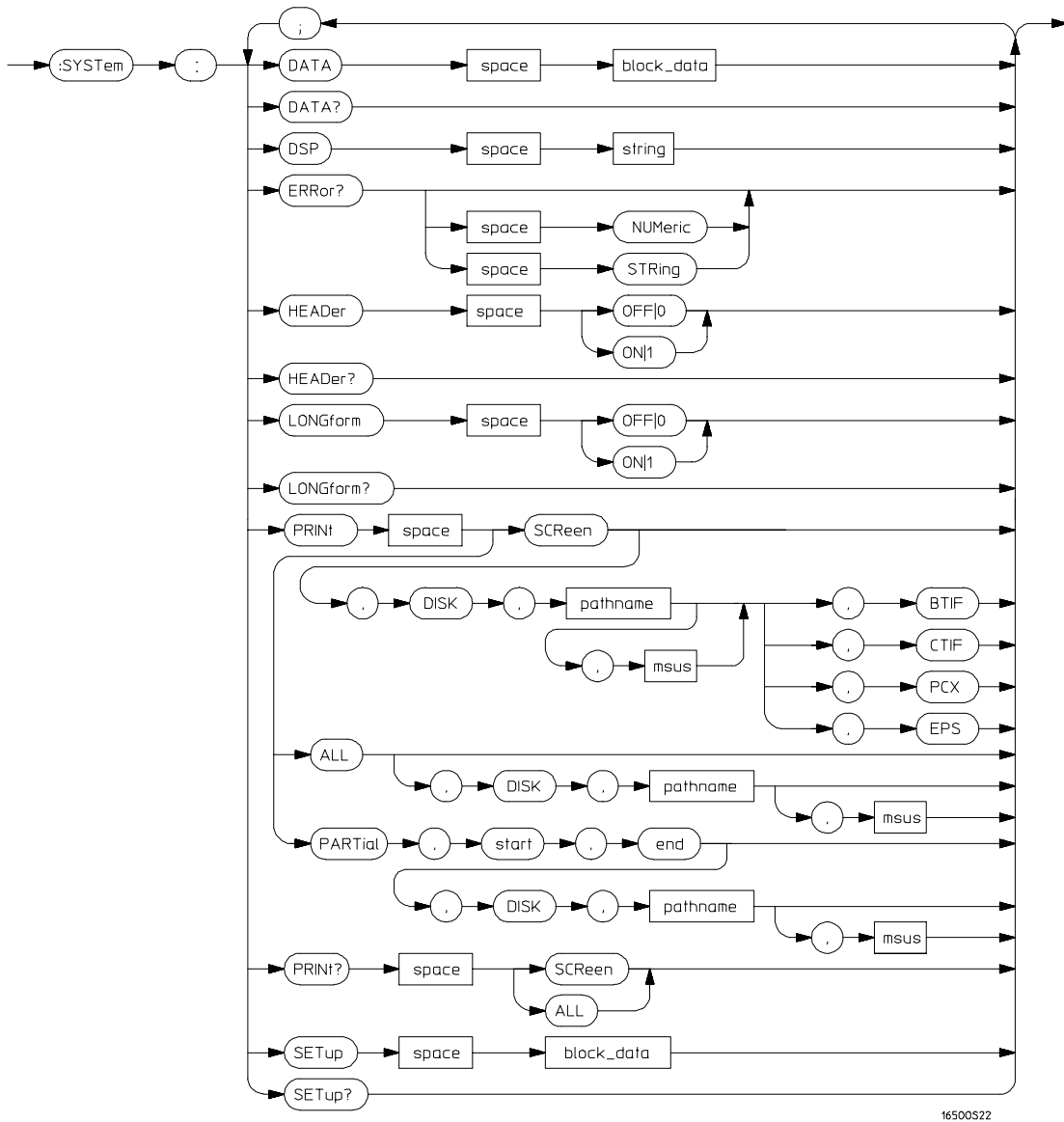
Introduction

SYSTEM subsystem commands control functions that are common to the entire logic analysis system, including formatting query responses and enabling reading and writing to the advisory line of the instrument.

Refer to figure 10-1 and table 10-1 for the SYSTEM Subsystem commands syntax diagram. The SYSTEM Subsystem commands are:

- DATA
- DSP
- ERRor
- HEADer
- LONGform
- PRINT
- SETup

Figure 10-1



16500S22

System Subsystem Commands Syntax Diagram

Table 10-1

SYSTEM Parameter Values

Parameter	Values
block_data	Data in IEEE 488.2 format.
string	A string of up to 68 alphanumeric characters.
pathname	A string of up to 10 alphanumeric characters for LIF in the following form: NNNNNNNNNN or A string of up to 64 alphanumeric characters for DOS in one of the following forms: NNNNNNNN . NNN when the file resides in the present working directory or \\NAME_DIR\\FILENAME when the files does not reside in the present working directory

DATA

Command :SYSTEM:DATA <block_data>

The DATA command allows you to send and receive acquired data to and from a controller in block form. This helps saving block data for:

- Reloading the logic analysis system
- Processing data later in the logic analysis system
- Processing data in the controller.

The format and length of block data depends on the instruction being used and the configuration of the instrument. This chapter describes briefly the syntax of the Data command and query; however, the mainframe by itself does not have acquired data. Therefore, the DATA command and query are described in detail in the respective module *Programmer's Guides*.

Because the capabilities of the DATA command and query vary for individual modules, a complete chapter is dedicated to the DATA command and query in each of the module *Programmer's Guides*. The dedicated chapter is called "DATA and SETup Commands."

Example

OUTPUT XXX; ":SYSTEM:DATA" <block_data>

<block_data> <block_length_specifier><section>

<block_length_specifier> #8<length>

<length> The total length of all sections in byte format (must be represented with 8 digits)

<section> <section_header><section_data>

<section_header> 16 bytes, described in the "Section Header Description" section of the individual module *Programmer's Guides*.

<section_data> The format depends on the type of data

SYSTEM Subsystem
DSP (Display)

Query : SYSTem:DATA?

The SYSTem:DATA query returns the block data. The data sent by the SYSTem:DATA query reflects the configuration of the a selected module when the last acquisition was performed. Any changes made since then through either front-panel operations or programming commands do not affect the stored data. Since the mainframe does not acquire data, refer to the appropriate module *Programmer's Guide* for more details.

Returned Format [:SYSTem:DATA] <block_data><NL>

Example

See the *Programmer's Guide* for the selected module for an example.

DSP (Display)

Command : SYSTem:DSP <string>

The DSP command writes the specified quoted string to a device-dependent portion of the instrument display.

 <string> A string of up to 68 alphanumeric characters

Example

OUTPUT XXX; ":SYSTem:DSP 'The message goes here' "

ERRor

Query :SYSTEM:ERRor? [NUMeric|STRing]

The ERRor query returns the oldest error from the error queue. The optional parameter determines whether the error string should be returned along with the error number. If no parameter is received, or if the parameter is NUMeric, then only the error number is returned. If the value of the parameter is STRing, then the error should be returned in the following form:

<error_number>,<error_message (string)>

A complete list of error messages for the HP 16500B logic analysis system is shown in chapter 7, "Error Messages." If no errors are present in the error queue, a zero (No Error) is returned.

Returned Formats

Numeric:

[:SYSTEM:ERRor] <error_number><NL>

String:

[:SYSTEM:ERRor] <error_number>,<error_string><NL>

<error_number> An integer

<error_string> A string of alphanumeric characters

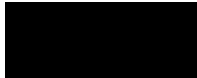
Examples

Numeric:

```
10 OUTPUT XXX;":SYSTEM:ERROR?"
20 ENTER XXX;Numeric
```

String:

```
50 OUTPUT XXX;":SYST:ERR? STRING"
60 ENTER XXX;String$
```



HEADer

Command : SYSTem:HEADer {{ON|1}}|{{OFF|0}}

The HEADer command tells the instrument whether or not to output a header for query responses. When HEADer is set to ON, query responses will include the command header.

Example OUTPUT XXX; ":SYSTEM:HEADER ON"

Query : SYSTem:HEADer?

The HEADer query returns the current state of the HEADer command.

Returned Format [:SYSTem:HEADer] {1|0}<NL>

Example OUTPUT XXX; ":SYSTEM:HEADER?"

Headers should be turned off when returning values to numeric variables.

LONGform

Command :SYSTem:LONGform {{ON|1}}|{{OFF|0}}

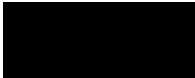
The LONGform command sets the long form variable, which tells the instrument how to format query responses. If the LONGform command is set to OFF, command headers and alpha arguments are sent from the instrument in the abbreviated form. If the LONGform command is set to ON, the whole word will be output. This command has no affect on the input data messages to the instrument. Headers and arguments may be input in either the long form or short form regardless of how the LONGform command is set.

Example OUTPUT XXX; ":SYSTEM:LONGFORM ON"

Query :SYSTem:LONGform?

Returned Format The query returns the status of the LONGform command.
 [:SYSTem:LONGform] {1|0}<NL>

Example OUTPUT XXX; ":SYSTEM:LONGFORM?"



PRINT

Commands :SYSTEM:PRINT ALL[,DISK, <pathname>[,<msus>]]
 :SYSTEM:PRINT PARTIAL,<start>,<end>
 [,DISK, <pathname>[,<msus>]]
 :SYSTEM:PRINT SCREEN[,DISK, <pathname> [,<msus>],
 {BTIF|CTIF|PCX|EPS}]

The PRINT command initiates a print of the screen or listing buffer over the current PRINTER communication interface to the printer or to a file on the disk. The PRINT SCREEN option allows you to specify a graphics type. The BTIF option formats the screen data in black-and-white TIF. The CTIF and PCX options format the data in color TIF and color PCX respectively. EPS specifies Encapsulated PostScript format.

If a file name extension is not specified in the command, the correct extension will be appended to the file name automatically. The file name extension is TIF for both BTIF and CTIF options and PCX is the extension for the PCX option.

The PRINT PARTIAL command is valid in certain listing menus. It allows you to specify a starting and ending state number so you can print a portion of the listing to the printer or to a disk file.

 <pathname> A string of up to 10 alphanumeric characters for LIF in the following form:

NNNNNNNNNN

or

A string of up to 64 alphanumeric characters for DOS in one of the following forms:

NNNNNNNN.NNN when the file resides in the present working directory

or

\NAME_DIR\FILENAME when the files does not reside in the present working directory

<msus> Mass Storage Unit specifier. INTERNAL0 for the hard disk drive and INTERNAL1 for the flexible disk drive.

<start> An integer specifying a state number.

<end>

Examples

This instruction prints the screen to the printer:

```
OUTPUT XXX; ":SYSTEM:PRINT SCREEN"
```

This instruction prints all, for example the state listing, to a file with a file name STATE:

```
OUTPUT 707; ":SYSTEM:PRINT ALL, DISK, 'STATE' "
```

This instruction prints part of a listing file to disk:

```
OUTPUT XXX; ":SYSTEM:PRINT PARTIAL,-9,30,DISK, 'LISTING',INT0"
```

This instruction prints a black-and-white TIF file to the hard drive:

```
OUTPUT XXX; ":SYSTEM:PRINT SCREEN, DISK, 'PICTURE', INTO, BTIF"
```

Query

```
:SYSTEM:PRINT? {SCREEN|ALL}
```

The PRINT query sends the screen or listing buffer data over the current CONTROLLER communication interface to the controller.

The print query should NOT be sent in conjunction with any other command or query on the same command line. The print query never returns a header. Also, since response data from a print query may be sent directly to a printer without modification, the data is not returned in block mode.

PRINT? ALL is only available in menus that have the "Print All" option available on the front panel. For more information, refer to the *HP 16500B Logic Analysis System User's Reference*.

Example

```
OUTPUT 707; ":SYSTEM:PRINT? SCREEN"
```

SETup

Command

```
:SYSTEM:SETup <block_data>
```

The :SYSTem:SETup command configures the logic analysis system as defined by the block data sent by the controller. This chapter describes briefly the syntax of the Setup command and query for the mainframe. Because of the capabilities and importance of the Setup command and query for individual modules, a complete chapter is dedicated to it in each of the module *Programmer's Guides*. The dedicated chapter is called "DATA and SETup Commands."

<block_data> <block_length_specifier><section>
<block_length_specifier> #8<length>
<length> The total length of all sections in byte format (must be represented with 8 digits)
<section> <section_header><section_data>
<section_header> 16 bytes, described in the "Section Header Description" section in chapter 26.
<section_data> Format depends on the type of data
The total length of a section is 16 (for the section header) plus the length of the section data. So when calculating the value for <length>, don't forget to include the length of the section headers.

Example

OUTPUT XXX USING "#,K";":SYSTem:SETUP " <block_data>

Query

:SYSTem:SETup?

The SYSTem:SETup query returns a block of data that contains the current configuration to the controller.

Returned Format

[:SYSTem:SETup] <block_data><NL>

Example

See the *Programmer's Guide* for the selected module for an example.





MMEMory Subsystem

Introduction

The MMEMory (mass memory) subsystem commands provide access to both the hard and flexible disk drives. The HP 16500B Logic Analysis System supports the DOS (Disk Operating System) format on the hard drive and both DOS and LIF (Logical Information Format) on the flexible drive.

Refer to figure 11-1 and table 11-1 for the MMEMory Subsystem commands syntax diagram. The MMEMory subsystem commands are:

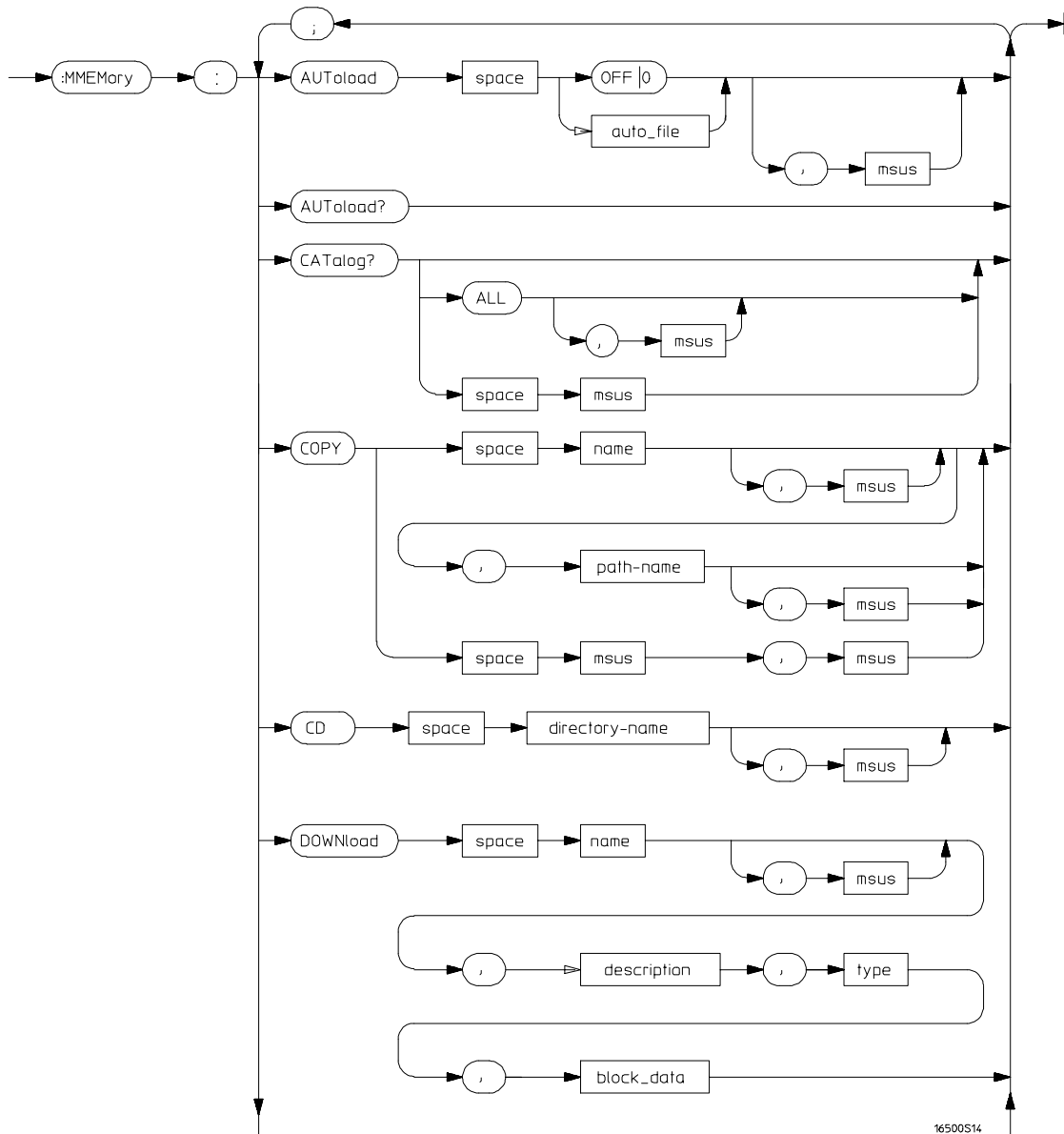
- AUToload
- CATalog
- CD (change directory)
- COPY
- DOWNload
- INITialize
- LOAD
- MKDir (make directory)
- MSI
- PACK
- PURGe
- PWD (present working directly)
- REName
- STORe
- UPLoad
- VOLume

<msus> refers to the mass storage unit specifier. INTernal0 specifies the hard disk drive and INTernal1 specifies the flexible disk drive.

If you are not going to store information to the flexible configuration disk, or if the flexible disk you are using contains information you need, it is advisable to write protect your disk. This will protect the contents of the disk from accidental damage due to incorrect commands being mistakenly sent.

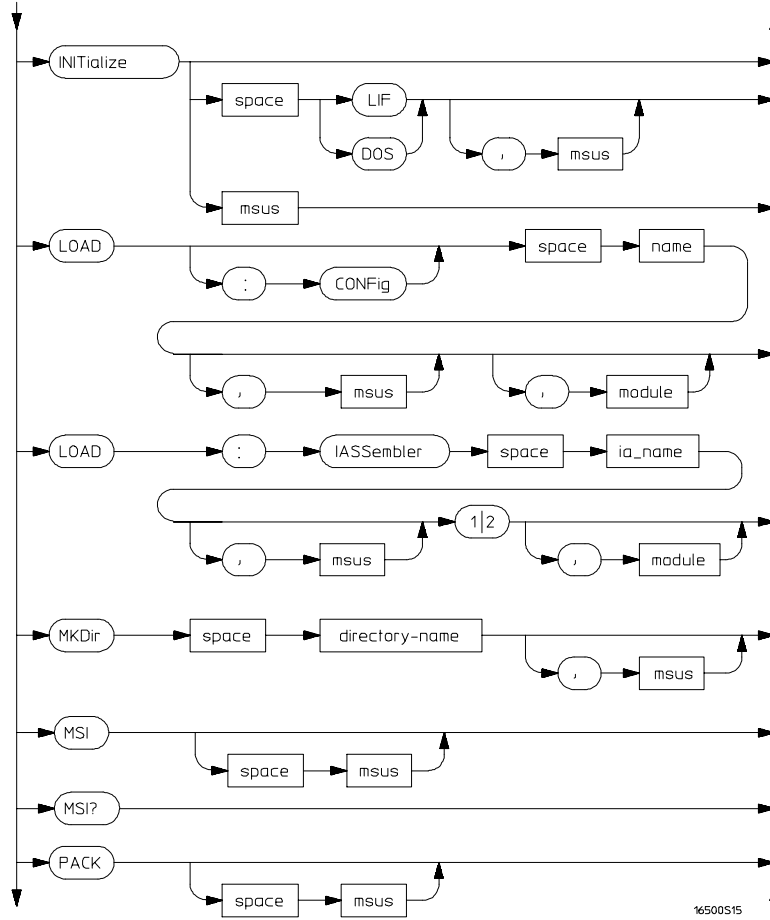


Figure 11-1



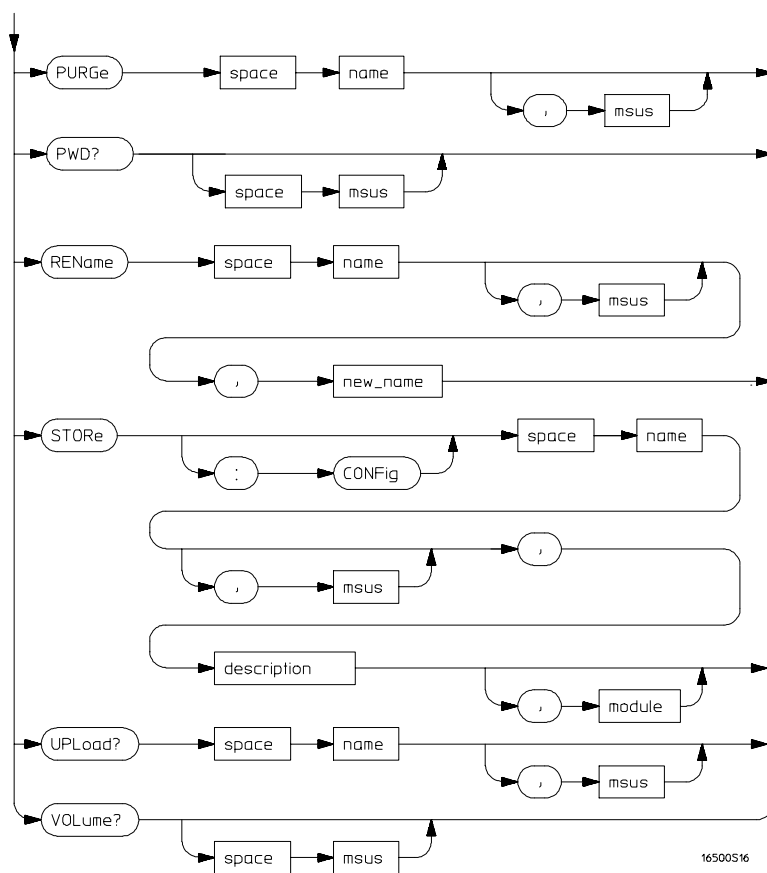
MMEemory Subsystem Commands Syntax Diagram

Figure 11-1 (Continued)



MMEMory Subsystem Commands Syntax Diagram (Continued)

Figure 11-1 (Continued)

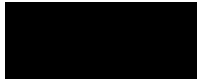


MMEMory Subsystem Commands Syntax Diagram (Continued)

Table 11-1

MMEMory Parameter Values

Parameter	Values
auto_file	A string of up to 10 alphanumeric characters for LIF in the following form: "NNNNNNNNNN" or A string of up to 12 alphanumeric characters for DOS in the following form: "NNNNNNNN.NNN"
msus	Mass Storage Unit specifier. <code>INTernal0</code> for the hard disk drive and <code>INTernal1</code> for the flexible disk drive.
name	A string of up to 10 alphanumeric characters for LIF in the following form: "NNNNNNNNNN" or A string of up to 12 alphanumeric characters for DOS in the following form: "NNNNNNNN.NNN"
path_name	A string of up to 64 characters for DOS disks ending in a file name. Separators can be the slash (/) or the backslash (\) character.
directory_name	A string of up to 64 characters for DOS disks ending in a directory name. Separators can be the slash (/) or the backslash (\) character. The string of two periods (..) represents the parent of the present working directory.
description	A string of up to 32 alphanumeric characters.
type	An integer, refer to table 11-2.
block_data	Data in IEEE 488.2 format.
module	An integer, -2 through 5 for the HP 16500B alone. -2 through 10 with the HP 16501A connected.
ia_name	A string of up to 10 alphanumeric characters for LIF in the following form: "NNNNNNNNNN" or A string of up to 12 alphanumeric characters for DOS in the following form: "NNNNNNNN.NNN"
new_name	A string of up to 10 alphanumeric characters for LIF in the following form: "NNNNNNNNNN" or A string of up to 12 alphanumeric characters for DOS in the following form: "NNNNNNNN.NNN"



AUToload

Command :MMEMemory:AUToload { {OFF|0} | {<auto_file>} } [, <msus>]

The AUToload command controls the autoloading feature which designates a set of configuration files to be loaded automatically the next time the instrument is turned on. The OFF parameter (or 0) disables the autoloading feature. A string parameter may be specified instead to represent the desired autoloading file. If the file is on the current drive, the autoloading feature is enabled to the specified file. The configuration files specified must reside in the root directory of the current drive.

<auto_file> A string of up to 10 alphanumeric characters for LIF in the following form:

NNNNNNNNNN

or

A string of up to 12 alphanumeric characters for DOS in the following form:

NNNNNNNN.NNN

<msus> Mass Storage Unit specifier. INTERNAL0 for the hard disk drive and INTERNAL1 for the flexible disk drive.

Examples

OUTPUT XXX; " :MMEMEMORY:AUTOLOAD OFF "
OUTPUT XXX; " :MMEMEMORY:AUTOLOAD 'FILE1_A' "
OUTPUT XXX; " :MMEMEMORY:AUTOLOAD 'FILE2 ', INTERNAL0 "

 **Query** :MMEMemory:AUToload?

The AUToload query returns 0 if the autoloading feature is disabled. If the autoloading feature is enabled, the query returns a string parameter that specifies the current autoloading file.

Returned Format [:MMEMemory:AUToload] { 0 | <auto_file> } , <msus> <NL>

Example

OUTPUT XXX; " :MMEMEMORY:AUTOLOAD? "

CATalog

Query :MMEMory:CATalog? [[All,] [<msus>]]

The CATalog query returns the directory of the disk in one of two block data formats. The directory consists of a 51 character string for each file on the disk when the ALL option is not used. Each file entry is formatted as follows:

```
"NNNNNNNNNNN TTTTTTT FFFFFFFFFFFFFFFFFFFFFFFFFFFFFFFF"
```

where N is the filename, T is the file type (see table 11-2), and F is the file description.

The optional parameter ALL returns the directory of the disk in a 70-character string as follows:

```
"NNNNNNNNNNN TTTTTTT FFFFFFFFFFFFFFFFFFFFFFFFFFFFFFFF  

DDMMYY HH:MM:SS"
```

where N is the filename, T is the file type (see table 11-2), F is the file description, and, D, M, Y, and HH:MM:SS are the date, month, year, and time respectively in 24-hour format.

<msus> Mass Storage Unit specifier. INTERNAL0 for the hard disk drive and INTERNAL1 for the flexible disk drive.

Returned Format [:MMEMory:CATalog] <block_data>

<block_data> ASCII block containing <filename> <file_type>
<file_description>

Example 1

This example is for sending the CATALOG? ALL query:

```
OUTPUT 707; ":MMEMORY:CATALOG? ALL"
```

Example 2

This example is for sending the CATALOG? query without the ALL option. Keep in mind if you do not use the ALL option with a DOS disk, each filename entry will be truncated at 51 characters:

```
OUTPUT 707; ":MMEMORY:CATALOG?"
```

CD (Change Directory)

Command :MMEMemory:CD <directory_name> [,<msus>]

The CD command allows you to change the current working directory on the hard disk or a DOS flexible disk. The command allows you to send path names of up to 64 characters for DOS format. Separators can be either the slash (/) or backslash (\) character. Both the slash and backslash characters are equivalent and are used as directory separators. The string containing double periods (..) represents the parent of the directory.

<directory_name> String of up to 64 characters for DOS disks ending in the new directory name

Examples

```
OUTPUT 707;":MMEMemory:CD 'CHILD_DIR' "  
OUTPUT 707;":MMEMemory:CD '..' "  
OUTPUT 707;":MMEMemory:CD '\SYSTEM\SOURCE_DIR\DIR', INTERNAL0"
```

The slash (/) character in DOS path names will be automatically translated to the backslash character (\) on the disk; therefore, any flexible DOS disk used in the HP 16500B will be compatible in DOS computers.

COPY

Command :MMEemory: COPY <name>[,<msus>] ,<new_name>[,<msus>]

The COPY command copies one file to a new file or an entire disk's contents to another disk. The two <name> parameters are the filenames. The first pair of parameters specifies the source file which must reside in the present working directory. The second pair specifies the destination file. An error is generated if the source file doesn't exist, or if the destination file already exists.

<name> A string of up to 10 alphanumeric characters for LIF in the following form:

NNNNNNNNNN

or

A string of up to 12 alphanumeric characters for DOS in the following form:

NNNNNNNN.NNN when the file resides in the present working directory

or

\NAME_DIR\FILENAME when the files does not reside in the present working directory

<new_name> A string of up to 10 alphanumeric characters for LIF in the following form:

NNNNNNNNNN

or

A string of up to 64 alphanumeric characters for DOS in one of the following forms:

NNNNNNNN.NNN when the file resides in the present working directory

or

\NAME_DIR\FILENAME when the files does not reside in the present working directory

<msus> Mass Storage Unit specifier. INTerna10 for the hard disk drive and INTerna11 for the flexible disk drive.

Examples

To copy the contents of "FILE1" to "FILE2":

```
OUTPUT XXX; ":MMEMORY:COPY 'FILE1', 'FILE2' "
```

To copy the contents of "FILE1" on the hard disk to "FILE2" on the flexible disk:

```
OUTPUT XXX; ":MMEMORY:COPY 'FILE1' INTERNAL0, 'FILE2', INTERNAL1 "
```

DOWNload

Command

```
:MMEMory:DOWNload <name>[,<msus>],<description>,  
<type>,<block_data>
```

The DOWNload command downloads a file to the mass storage device. The <name> parameter specifies the filename, the <description> parameter specifies the file description, and the <block_data> contains the contents of the file to be downloaded.

Table 11-2 lists the file types for the <type> parameter.

<name> A string of up to 10 alphanumeric characters for LIF in the following form:

```
NNNNNNNNNN
```

or

A string of up to 12 alphanumeric characters for DOS in the following form:

```
NNNNNNNN.NNN
```

 when the file resides in the present working directory

or

```
\NAME_DIR\FILENAME
```

 when the files does not reside in the present working directory

<msus> Mass Storage Unit specifier. INTernal0 for the hard disk drive and INTernal1 for the flexible disk drive.

<description> A string of up to 32 alphanumeric characters

<type> An integer (see table 11-2)

<block_data> Contents of file in block data format

Example

OUTPUT XXX;":MMEMORY:DOWNLOAD 'SETUP ',INTERNAL0,'FILE CREATED FROM SETUP
 QUERY',-16127,#800000643..."

Table 11-2

File Types

File	File Type
HP 16500B System Software	-15603
HP 16500B Option Software	-15602
HP 16500A or HP 16500B System Configuration	-16127
Autoload File	-15615
Inverse Assembler	-15614
DOS file (from Print to Disk)	-5813
HP 16510A/B Configuration	-16097
HP 16511B Configuration	-16098
HP 16515A Configuration	-16127
HP 16516A Configuration	-16126
HP 16520A Configuration	-16107
HP 16521A Configuration	-16106
HP 16530A Configuration	-16117
HP 16531A Configuration	-16116
HP 16532A Configuration	-16115
HP 16540A Configuration	-16088
HP 16541A Configuration	-16087
HP 16542A Master Card Configuration	-16086
HP 16542A Expansion Card Configuration	-16085
HP 16550A Master Card Configuration	-16096
HP 16550A Expansion Card Configuration	-16095



INITialize

Command :MMEMory:INITialize [{LIF|DOS}[,<msus>]]

The INITialize command formats the disk in DOS (Disk Operating System) on the hard drive or either DOS or LIF (Logical Information Format) on the flexible drive. If no format is specified, then the initialize command will format the disk in the DOS format. LIF format is not allowed on the hard drive.

<msus> Mass Storage Unit specifier. INTERNAL0 for the hard disk drive and INTERNAL1 for the flexible disk drive.

Examples

```
OUTPUT XXX; ":MMEMORY:INITIALIZE DOS "  
OUTPUT XXX; ":MMEMORY:INITIALIZE LIF , INTERNAL1 "  
OUTPUT XXX; ":MMEMORY:INITIALIZE DOS , INTERNAL0 "
```

Once executed, the initialize command formats the specified disk, permanently erasing all existing information from the disk. After that, there is no way to retrieve the original information.

LOAD [:CONFig]

Command :MMEMory:LOAD[:CONFig] <name>[, <msus>][, <module>]

The LOAD command loads a configuration file from the disk into the modules, software options, or the system. The <name> parameter specifies the filename from the disk. The optional <module> parameter specifies which module(s) to load the file into. The accepted values are -2 through 10. Not specifying the <module> parameter is equivalent to performing a 'LOAD ALL' from the front panel which loads the appropriate file for both the system and the modules, and any software option.

<name> A string of up to 10 alphanumeric characters for LIF in the following form:

NNNNNNNNNN

or

A string of up to 12 alphanumeric characters for DOS in the following form:

NNNNNNNN.NNN when the file resides in the present working directory

or

\NAME_DIR\FILENAME when the files does not reside in the present working directory

<msus> Mass Storage Unit specifier. INTerna10 for the hard disk drive and INTerna11 for the flexible disk drive.

<module> An integer, -2 through 5 for the HP 16500B alone. -2 through 10 with the HP 16501A connected.

Examples

```
OUTPUT XXX;":MMEMORY:LOAD:CONFIG 'FILE ' "
OUTPUT XXX;":MMEMORY:LOAD 'FILE ',0"
OUTPUT XXX;":MMEM:LOAD:CONFIG 'FILE A',INTERNAL0,1"
```

LOAD :IASsembler

Command :MMEMemory:LOAD:IASsembler <IA_name>[,<msus>] , {1|2}
[,<module>]

This variation of the LOAD command allows inverse assembler files to be loaded into a module that performs state analysis. The <IA_name> parameter specifies the inverse assembler filename from the desired <msus>. The parameter after the optional <msus> specifies which machine to load the inverse assembler into. For example, a 1 following <msus> specifies that the inverse assembler files will be loaded into MACHINE 1 of the specified module.

The optional <module> parameter is used to specify which slot the state analyzer is in. If this parameter is not specified, the state analyzer in the currently selected module will be loaded with the inverse assembler file.

<IA_name> A string of up to 10 alphanumeric characters for LIF in the following form:

NNNNNNNNNN

or

A string of up to 12 alphanumeric characters for DOS in the following form:

NNNNNNNN.NNN when the file resides in the present working directory

or

\NAME_DIR\FILENAME when the files does not reside in the present working directory

<msus> Mass Storage Unit specifier. INTERNAL0 for the hard disk drive and INTERNAL1 for the flexible disk drive.

<module> An integer, 1 through 5 for the HP 16500B alone. 1 through 10 with an HP 16501A connected.

Examples

OUTPUT XXX; ":MMEMEMORY:LOAD:IASSEMBLER 'I68020 IP',1"
OUTPUT XXX; ":MMEMEMORY:LOAD:IASSEMBLER 'I68020 IP',INTERNAL0,1,2"

MKDir (Make Directory)

Command :MMEMory:MKDir <directory_name> [,<msus>]

The MKDir command allows you to make a directory on the hard drive and a DOS disk in the flexible drive. Directories cannot be made on LIF disks. Make directory will make a directory under the present working directory on the current drive if the optional path is not specified. Separators can be either the slash (/) or backslash (\) character. Both the slash and backslash characters are equivalent and are used as directory separators. The string containing two periods (..) represents the parent of the present working directory.

<directory_name> String of up to 64 characters for DOS disks ending in the new directory name.

<msus> Mass Storage Unit specifier. INTerna10 for the hard disk drive and INTerna11 for the flexible disk drive.

Examples

```
OUTPUT XXX;" :MMEMORY:MKDIR 'NEW.DIR' "
OUTPUT XXX;" :MMEM:MKD '\SYSTEM\NEW.DIR',INT0 "
```

The slash (/) character in DOS path names will be automatically translated to the backslash character (\) on the disk; therefore, any flexible DOS disk used in the HP 16500B will be compatible in DOS computers.

MSI (Mass Storage Is)

Command :MMEMoRY:MSI [<msus>]

The MSI command selects a default mass storage device. INTerna10 selects the hard disk drive and INTerna11 selects the flexible disk drive. Once the MSI is selected it remains the default drive until another MSI command is sent to the system.

<msus> Mass Storage Unit specifier. INTerna10 for the hard disk drive and INTerna11 for the flexible disk drive.

Examples

OUTPUT XXX; " :MMEMORY:MSI "
OUTPUT XXX; " :MMEM:MSI INTERNAL0 "

Query :MMEMoRY:MSI?

The MSI? query returns the current MSI setting.

Returned Format [:MMEMoRY:MSI] <msus><NL>

Example

OUTPUT XXX; " :MMEMORY:MSI? "

PACK

Command :MMEMOry:PACK [<msus>]

The PACK command packs the files on the LIF disk the disk in the drive. If a DOS disk is in the drive when the PACK command is sent, no action is taken.

<msus> Mass Storage Unit specifier. INTerna10 for the hard disk drive and
 INTerna11 for the flexible disk drive.

Examples

OUTPUT XXX; " :MMEMORY:PACK "
OUTPUT XXX; " :MMEM:PACK INTERNAL0 "

PURGe

Command :MMEMory:PURGe <name> [, <msus>]

The PURGe command deletes files and directories from the disk in the specified drive. The PURge command only purges directories when the directory is empty. If the PURge command is sent with a directory name and the directory contains files, the message "Directory contains files" is displayed and the command is ignored. The <name> parameter specifies the file name to be deleted.

<name> A string of up to 10 alphanumeric characters for LIF in the following form:

NNNNNNNNNN

or

A string of up to 12 alphanumeric characters for DOS in the following form:

NNNNNNNN.NNN when the file resides in the present working directory

or

\NAME_DIR\FILENAME when the files does not reside in the present working directory

<msus> Mass Storage Unit specifier. INTerna10 for the hard disk drive and INTerna11 for the flexible disk drive.

Examples

This instuction purges the file named "FILE1" from the currently specified drive:

```
OUTPUT XXX; " :MMEMORY: PURGE 'FILE1' "
```

This instruction purges the file named "FILE1" from the hard drive:

```
OUTPUT XXX; " :MMEMORY: PURGE 'FILE1' , INTERNAL0 "
```

This instuction purges the directory named "NEWDIR" from the hard drive:

```
OUTPUT XXX; " :MMEMORY: PURGE 'NEWDIR' , INTERNAL0 "
```

Once executed, the purge command permanently erases all the existing information about the specified file. After that, there is no way to retrieve the original information.

PWD (Present Working Directory)

Query :MMEMory:PWD? [<msus>]

The PWD query returns the present working directory for the specified drive. If the <msus> option is not sent, the present working directory will be returned for the current drive.

Returned Format [:MMEMory:PWD] <directory> , <msus> <NL>

 <directory> String of up to 64 characters with the backslash (\) as separator for DOS and LIF disks.

 <msus> Mass Storage Unit specifier. INTernal10 for the hard disk drive and INTernal11 for the flexible disk drive.

Examples

```
OUTPUT XXX; " :MMEMORY:PWD? "  
OUTPUT XXX; " :MMEMORY:PWD? INTERNAL1 "
```

REName

Command :MMEMemory:REName <name> [, <msus>] , <new_name>

The REName command renames a file on the disk in the drive. The <name> parameter specifies the filename to be changed and the <new_name> parameter specifies the new filename.

You cannot rename a file to an already existing filename.

<name> A string of up to 10 alphanumeric characters for LIF in the following form:

NNNNNNNNNN

or

A string of up to 12 alphanumeric characters for DOS in the following form:

NNNNNNNN.NNN when the file resides in the present working directory

or

\NAME_DIR\FILENAME when the files does not reside in the present working directory

<msus> Mass Storage Unit specifier. INTerna10 for the hard disk drive and INTerna11 for the flexible disk drive.

<new name> A string of up to 10 alphanumeric characters for LIF in the following form:

NNNNNNNNNN

or

A string of up to 12 alphanumeric characters for DOS in the following form:

NNNNNNNN.NNN when the file resides in the present working directory

or

\NAME_DIR\FILENAME when the files does not reside in the present working directory

Examples

OUTPUT XXX; " :MMEMEMORY:RENAME 'OLDFILE' , 'NEWFILE' "

OUTPUT XXX; " :MME:REN 'OLDFILE' [, INTERNAL1] , 'NEWFILE' "

STORe [:CONFig]

Command :MMEemory:STORe [:CONFig]<name>[,<msus>] ,
 <description>[,<module>]

The STORe command stores module or system configurations onto a disk. The [:CONFig] specifier is optional and has no effect on the command. The <name> parameter specifies the file on the disk. The <description> parameter describes the contents of the file. The optional <module> parameter allows you to store the configuration for either the system or the modules. 0 refers to the system. 1 through 5 refers to the modules in the mainframe alone and 1 through 10 refers to the mainframe with an expansion frame connected.

If the optional <module> parameter is not specified, the configurations for both the system and logic analyzer are stored.

<name> A string of up to 10 alphanumeric characters for LIF in the following form:

NNNNNNNNNN

or

A string of up to 12 alphanumeric characters for DOS in the following form:

NNNNNNNN.NNN when the file resides in the present working directory

or

\NAME_DIR\FILENAME when the files does not reside in the present working directory

<msus> Mass Storage Unit specifier. INTernal0 for the hard disk drive and INTernal1 for the flexible disk drive.

<description> A string of up to 32 alphanumeric characters

<module> An integer, 1 through 5 for the HP 16500B alone. 1 through 10 with an HP 16501A connected.

Examples

```
OUTPUT XXX;":MME:STOR 'DEFAULTS','SETUPS FOR ALL MODULES"
OUTPUT XXX;":MEMORY:STORE:CONFIG 'STATEDATA',INTERNAL0,
'ANALYZER 1 CONFIG',1"
```

The appropriate module designator "_X" is added to all files when they are stored. "X" refers to either an __ (double underscore) for the system or an _(A through E) for an HP 16500B alone or an _(A through J) with an HP 16501A connected.

UPLoad

Query :MMEMemory:UPLoad? <name> [, <msus>]

The UPLoad query uploads a file. The <name> parameter specifies the file to be uploaded from the disk. The contents of the file are sent out of the instrument in block data form.

This command should only be used for HP 16550A configuration files.

<name> A string of up to 10 alphanumeric characters for LIF in the following form:

NNNNNNNNNN

or

A string of up to 12 alphanumeric characters for DOS in the following form:

NNNNNNNN.NNN when the file resides in the present working directory

or

\NAME_DIR\FILENAME when the files does not reside in the present working directory

<msus> Mass Storage Unit specifier. INTerna10 for the hard disk drive and INTerna11 for the flexible disk drive.

Returned Format [:MMEMemory:UPLoad] <block_data><NL>

Example

```
10 DIM Block$[32000]      !allocate enough memory for block data
20 DIM Specifier$[2]
30 OUTPUT XXX;":EOI ON"
40 OUTPUT XXX;":SYSTEM HEAD OFF"
50 OUTPUT XXX;":MMEMORY:UPLOAD? 'FILE1'"      !send upload query
60 ENTER XXX USING "#,2A";Specifier$      !read in #8
70 ENTER XXX USING "#,8D";Length      !read in block length
80 ENTER XXX USING "-K";Block$      !read in file
90 END
```



VOLume

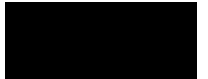
Query :MMEMemory:VOLume? [<msus>]

The VOLume query returns the volume type of the disk. The volume types are DOS or LIF. Question marks (???) are returned if there is no disk, if the disk is not formatted, or if a disk has a format other than DOS or LIF.

<msus> Mass Storage Unit specifier. INTerna10 for the hard disk drive and INTerna11 for the flexible disk drive.

Returned Format [:MMEMemory:VOLume] {DOS | LIF | ???} <NL>

Example OUTPUT XXX; " :MMEMemory:VOLUME? "



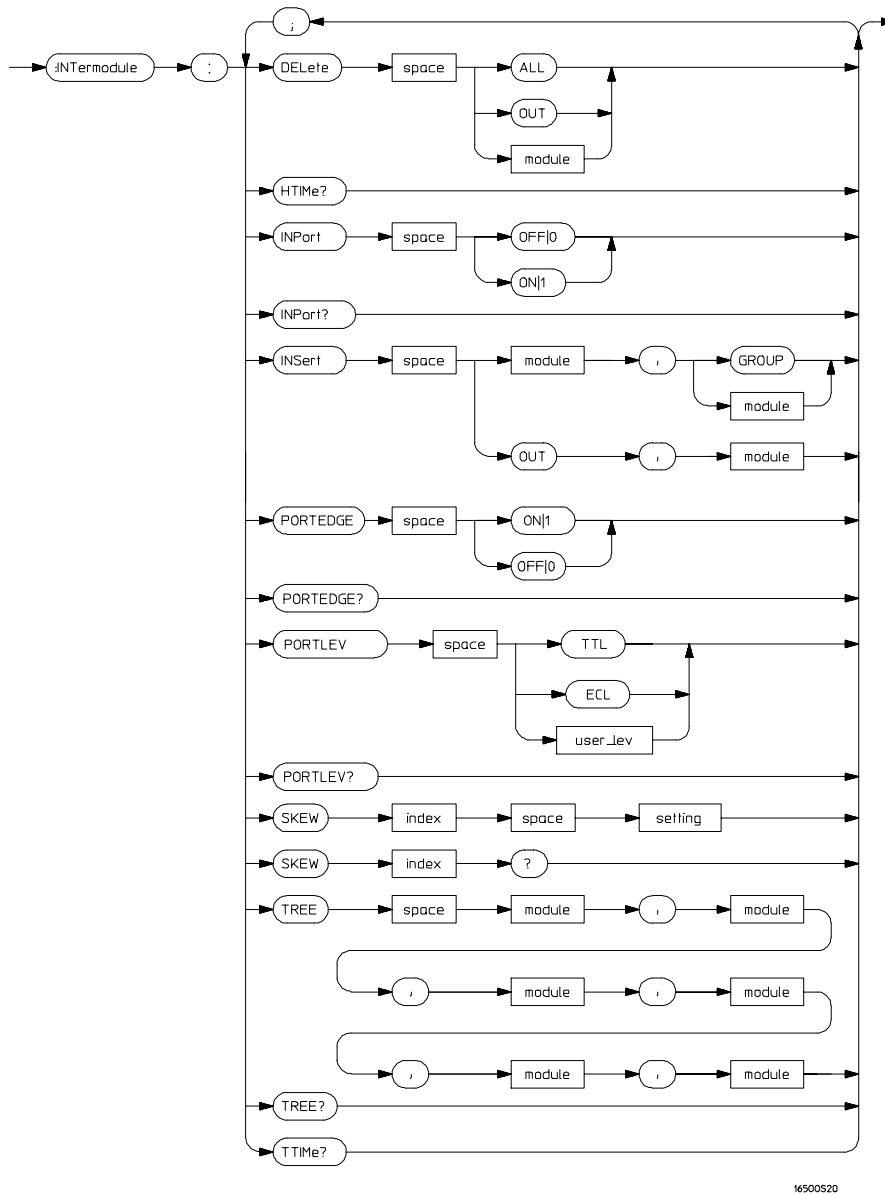
INTermodule Subsystem

Introduction

The INTermodule subsystem commands specify intermodule arming from the rear-panel input BNC (ARMIN) or to the rear-panel output BNC (ARMOUT). Refer to figure 12-1 and table 12-1 for the INTermodule Subsystem commands syntax diagram. The INTermodule commands are:

- DELeTe
- HTIMe
- INPort
- INSert
- PORTEDGE
- PORTLEV
- SKEW
- TREE
- TTIMe

Figure 12-1



16500520

Intermodule Subsystem Commands Syntax Diagram

Table 12-1

INTermodule Parameter Values

Parameter	Value
module	An integer, 1 through 5 for HP 16500B alone. 1 through 10 with the HP 16501A connected.
user_lev	A real number from -4.0 to +5.0 volts in 0.02 volt increments
index	An integer, 1 through 5 for HP 16500B alone. 1 through 10 with the HP 16501A connected.
setting	A numeric, - 1.0 to 1.0 in seconds.

:INTermodule

Selector

: INTermodule

The INTermodule selector specifies INTermodule as the subsystem the commands or queries following will refer to. Because the INTermodule command is a root level command, it will normally appear as the first element of a compound header.

Example

OUTPUT XXX; " : INTERMODULE : HTIME? "

DELeTe

Command :DELeTe {ALL|OUT|<module>}

The DELeTe command is used to delete a module, PORT OUT, or an entire intermodule tree. The <module> parameter sent with the delete command refers to the slot location of the module.

<module> An integer, 1 through 5 for HP 16500B alone. 1 through 10 with the HP 16501A connected.

Example

```
OUTPUT XXX; ":INTERMODULE:DELETE ALL"  
OUTPUT XXX; ":INTERMODULE:DELETE 1"
```

HTIME

Query : HTIME?

The HTIME query returns a value representing the internal hardware skew in the Intermodule configuration. If there is no internal skew, 9.9E37 is returned.

The internal hardware skew is only a display adjustment for time-correlated waveforms. The value returned is the average propagation delay of the trigger lines through the intermodule bus circuitry. These values are for reference only because the values returned by TTIME include the internal hardware skew represented by HTIME.

Returned Format [:INTermodule:HTIME] <value_1>, <value_2>, <value_3>, <value_4>, <value_5>, <value_6>, <value_7>, <value_8>, <value_9>, <value_10><NL>

<value_1> Skew for module in slot A (real number)

<value_2> Skew for module in slot B (real number)

<value_3> Skew for module in slot C (real number)

<value_4> Skew for module in slot D (real number)

<value_5> Skew for module in slot E (real number)

<value_6> Skew for module in slot F (real number)

<value_7> Skew for module in slot G (real number)

<value_8> Skew for module in slot H (real number)

<value_9> Skew for module in slot I (real number)

<value_10> Skew for module in slot J (real number)

Example OUTPUT XXX; " : INTERMODULE: HTIME? "

INPort

Command : INPort { {ON|1} | {OFF|0} }

The INPort command causes intermodule acquisitions to be armed from the Input port.

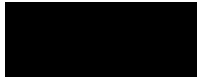
Example OUTPUT XXX; " : INTERMODULE: INPORT ON "

Query : INPort?

The INPort query returns the current setting.

Returned Format [: INtermodule: INPort] {1|0} <NL>

Example OUTPUT XXX; " : INTERMODULE: INPORT? "



INSert

Command :INSert {<module> |OUT}, {GROUP |<module>}

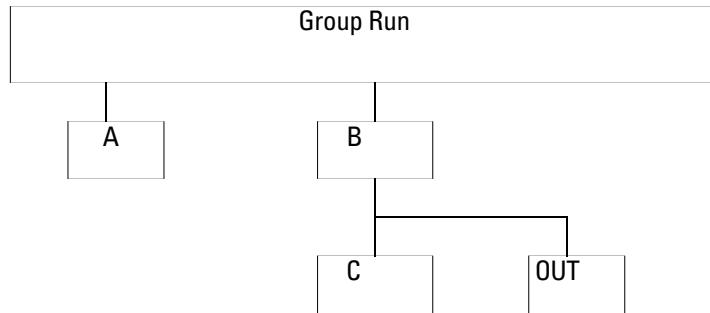
The INSert command adds PORT OUT to the Intermodule configuration. The first parameter selects the module or PORT OUT to be added to the intermodule configuration, and the second parameter tells the instrument where the module or PORT OUT will be located. 1 through 5 corresponds to the slot location of the modules A through E for the HP 16500B alone and 1 through 10 corresponds to slot location of modules A through J when an HP 16501A is connected.

<module> An integer, 1 through 5 for HP 16500B alone. 1 through 10 with the HP 16501A connected.

Examples

```
OUTPUT XXX; " : INTERMODULE : INSERT 1 , GROUP "  
OUTPUT XXX; " : INTERMODULE : INSERT 2 , GROUP "  
OUTPUT XXX; " : INTERMODULE : INSERT 3 , 2 ; INSERT OUT , 2 "
```

The following figure shows the result of the example output commands:



PORTEDGE

Command : PORTEDGE <edge_spec>

The PORTEDGE command sets the port input BNC to respond to either a rising edge or falling edge for a trigger from an external source. The threshold level of the input signal is set by the PORTLEV command.

<edge_spec> A 1 or ON for rising edge or a 0 or OFF for falling edge.

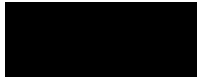
Example OUTPUT 707; " : INTERMODULE : PORTEDGE 1 "

Query : PORTEDGE?

The PORTEDGE query returns the current edge setting.

Returned Format [: INTERMODULE : PORTEDGE] { 1 | 0 } <NL>

Example OUTPUT XXX; " : INTERMODULE : PORTEDGE? "



PORTLEV

Command : PORTLEV {TTL|ECL|<user_lev>}

The PORTLEV (port level) command sets the threshold level at which the input BNC responds and produces an intermodule trigger. The preset levels are TTL and ECL. The user defined level is -4.0 volts to +5.0 volts.

<user_lev> A real number from -4.0 to + 5.0 volts in 0.02 volt increments.

Example

This statement sets the BNC threshold to ECL

```
OUTPUT XXX; " : INTERMODULE : PORTLEV ECL "
```

This statement sets the BNC threshold to -2.3 volts

```
OUTPUT XXX; " : INTERMODULE : PORTLEV -2.3 "
```

Query : INtermodule : PORTLEV?

The PORTlev query returns the current BNC threshold setting.

Returned Format [INtermodule : PORTLEV] { TTL | ECL | <user_lev> <NL> }

Example

```
OUTPUT XXX; " : INTERMODULE : PORTLEV? "
```

SKEW<N>

Command :SKEW<N> <setting>

The SKEW command sets the skew value for a module. The <N> index value is the module number (1 through 5 corresponds to the slot location of the modules A through E for the HP 16500B alone and 1 through 10 corresponds to slot location of modules A through J when an HP 16501A is connected). The <setting> parameter is the skew setting (- 1.0 to 1.0) in seconds.

<N> An integer, 1 through 5 for HP 16500B alone. 1 through 10 with the HP 16501A connected.

<setting> A real number from -1.0 to 1.0 seconds

Example

OUTPUT XXX; " : INTERMODULE : SKEW2 3.0E-9 "

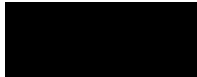
Query : SKEW<N>?

The query returns the user defined skew setting.

Returned Format [INTERmodule : SKEW<N>] <setting><NL>

Example

OUTPUT XXX; " : INTERMODULE : SKEW1? "



TREE

Command :TREE <module> , <module> , <module> , <module> ,
 <module> , <module>

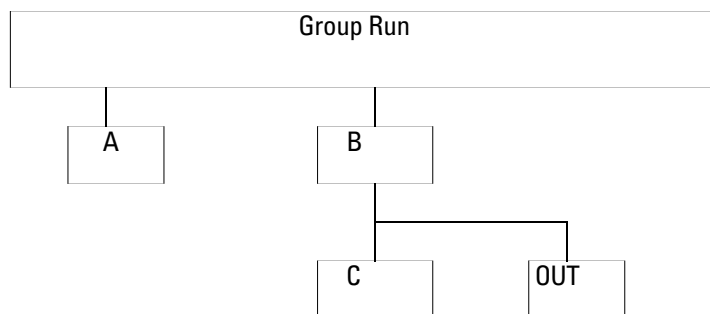
The TREE command allows an intermodule setup to be specified in one command. The first parameter is the intermodule arm value for module A (logic analyzer). The second parameter corresponds to the intermodule arm value for PORT OUT. A -1 means the module is not in the intermodule tree, a 0 value means the module is armed from the Intermodule run button (Group run), and a positive value indicates the module is being armed by another module with the slot location 1 to 10. 1 through 10 corresponds to slots A through J.

<module> An integer, -1 through for an HP 16500B alone. -1 through 10 with the HP 16501A connected.

Example

OUTPUT XXX; " : INTERMODULE : TREE 0 , 0 , 2 , -1 , -1 , 2 "

The following figure shows the result of the example output commands:



Query : TREE?

The TREE? query returns a string that represents the intermodule tree. A -1 means the module is not in the intermodule tree, a 0 value means the module is armed from the Intermodule run button (Group run), and a positive value indicates the module is being armed by another module with the slot location 1 to 10. 1 through 10 corresponds to the slots A through J.

Returned Format [INtermodule:TREE] <module>,<module>,<module>,<module>,<module><NL>

Example OUTPUT XXX; " : INTERMODULE:TREE? "

TTIME

Query : TTIME?

The TTIME query returns five values (HP 16500B alone) representing the absolute intermodule trigger time for all of the modules in the Intermodule configuration. When an HP 16501A is connected, the TTIME query returns 10 values. The first value is the trigger time for the module in slot A, the second value is for the module in slot B, the third value is for slot C, etc.

The value 9.9E37 is returned when:

- No module is installed in the corresponding slot;
- The module in the corresponding slot is not time correlated; or
- A time correlatable module did not trigger.

The trigger times returned by this command have already been offset by the INtermodule:SKEW values and internal hardware skews (INtermodule:HTIME).

INTermodule Subsystem TTIME

Returned Format [:INTermodule:TTIME] <value 1>,<value 2>,<value 3>,
<value 4>,<value 5>,<value 6>,<value 7>,<value 8>,
<value 9>,<value 10><NL>

<value 1> Trigger time for module in slot A (real number)
<value 2> Trigger time for module in slot B (real number)
<value 3> Trigger time for module in slot C (real number)
<value 4> Trigger time for module in slot D (real number)
<value 5> Trigger time for module in slot E (real number)
<value 6> Trigger time for module in slot F (real number)
<value 7> Trigger time for module in slot G (real number)
<value 8> Trigger time for module in slot H (real number)
<value 9> Trigger time for module in slot I (real number)
<value10> Trigger time for module in slot J (real number)

Example

OUTPUT XXX; " : INTERMODULE : TTIME? "

Part 3

13 Programming Examples 13-1

Programming Examples



Programming Examples

Introduction

This chapter contains short, usable, and tested program examples that cover the most asked for examples. The examples are written in HP BASIC 6.2.

- Transferring the mainframe configuration between the mainframe and the controller
- Checking for intermodule measurement completion
- Sending queries to the mainframe
- Getting ASCII data with PRINT? All query
- Reading a disk catalog
- Printing to the disk using PRINT? ALL

Transferring the Mainframe Configuration

This program uses the `SYSTEM:SETup?` query to transfer the configuration of the mainframe to your controller. This program also uses the `SYSTEM:SETup` command to transfer a mainframe configuration from the controller back to the mainframe. The configuration data will set up the mainframe according to the data. It is useful for getting configurations for setting up the mainframe by the controller. This command and query differs from the `SYSTEM:DATA?` command and query because it only transfers the configuration and not the acquired data. Because the mainframe, by itself, does not acquire data the `SYSTEM:DATA?` command and query is only useful for modules.

```

10  ! ***** SETUP COMMAND AND QUERY EXAMPLE *****
20  !                               for the HP 16500B/16501A Logic Analysis System
30  !
40  ! ***** CREATE TRANSFER BUFFER *****
50  ! Create a buffer large enough for the block data.
55  !
60  ASSIGN @Buff TO BUFFER [170000]
70  !
80  ! ***** INITIALIZE HPIB DEFAULT ADDRESS *****
90  !
100 REAL Address
110 Address=707
120 ASSIGN @Comm TO Address
130 !
140 CLEAR SCREEN
150 !
160 ! ***** INTITIALIZE VARIABLE FOR NUMBER OF BYTES *****
170 ! The variable "Numbytes" contains the number of bytes in the buffer.
180 !
190 REAL Numbytes
200 Numbytes=0
210 !
220 ! ***** RE-INITIALIZE TRANSFER BUFFER POINTERS *****
230 !
240 CONTROL @Buff,3;1
250 CONTROL @Buff,4;0
260 !

```

Programming Examples Transferring the Mainframe Configuration

```
270 ! ***** SEND THE SETUP QUERY *****
280 OUTPUT 707;":SYSTEM:HEADER ON"
290 OUTPUT 707;":SYSTEM:LONGFORM ON"
300 OUTPUT @Comm;"SELECT 0"
310 OUTPUT @Comm;":SYSTEM:SETUP?"
320 !
330 ! ***** ENTER THE BLOCK SETUP HEADER *****
340 ! Enter the block setup header in the proper format.
350 !
360 ENTER @Comm USING "#,B";Byte
370 PRINT CHR$(Byte);
380 WHILE Byte<>35
390     ENTER @Comm USING "#,B";Byte
400     PRINT CHR$(Byte);
410 END WHILE
420 ENTER @Comm USING "#,B";Byte
430 PRINT CHR$(Byte);
440 Byte=Byte-48
450 IF Byte=1 THEN ENTER @Comm USING "#,D";Numbytes
460 IF Byte=2 THEN ENTER @Comm USING "#,DD";Numbytes
470 IF Byte=3 THEN ENTER @Comm USING "#,DDD";Numbytes
480 IF Byte=4 THEN ENTER @Comm USING "#,DDDD";Numbytes
490 IF Byte=5 THEN ENTER @Comm USING "#,DDDDD";Numbytes
500 IF Byte=6 THEN ENTER @Comm USING "#,DDDDDD";Numbytes
510 IF Byte=7 THEN ENTER @Comm USING "#,DDDDDDD";Numbytes
520 IF Byte=8 THEN ENTER @Comm USING "#,DDDDDDDD";Numbytes
530 PRINT Numbytes
540 !
550 ! ***** TRANSFER THE SETUP *****
560 ! Transfer the setup from the mainframe to the buffer.
570 !
580 TRANSFER @Comm TO @Buff;COUNT Numbytes,WAIT
600 !
610 ENTER @Comm USING "-K";Length$
620 PRINT "LENGTH of Length string is";LEN(Length$)
630 !
640 PRINT "**** GOT THE SETUP ****"
650 PAUSE
660 ! ***** SEND THE SETUP *****
670 ! Make sure buffer is not empty.
680 !
690 IF Numbytes=0 THEN
700     PRINT "BUFFER IS EMPTY"
710     GOTO 1170
720 END IF
```

```
730 !
740 ! ***** SEND THE SETUP COMMAND *****
750 ! Send the Setup command
760 !
770 OUTPUT @Comm USING "#,15A";":SYSTEM:SETUP #"
780 PRINT "SYSTEM:SETUP command has been sent"
790 PAUSE
800 !
810 ! ***** SEND THE BLOCK SETUP *****
820 ! Send the block setup header to the mainframe in the proper format.
830 !
840 Byte=LEN(VAL$(Numbytes))
850 OUTPUT @Comm USING "#,B";(Byte+48)
860 IF Byte=1 THEN OUTPUT @Comm USING "#,A";VAL$(Numbytes)
870 IF Byte=2 THEN OUTPUT @Comm USING "#,AA";VAL$(Numbytes)
880 IF Byte=3 THEN OUTPUT @Comm USING "#,AAA";VAL$(Numbytes)
890 IF Byte=4 THEN OUTPUT @Comm USING "#,AAAA";VAL$(Numbytes)
900 IF Byte=5 THEN OUTPUT @Comm USING "#,AAAAA";VAL$(Numbytes)
910 IF Byte=6 THEN OUTPUT @Comm USING "#,AAAAAA";VAL$(Numbytes)
920 IF Byte=7 THEN OUTPUT @Comm USING "#,AAAAAAA";VAL$(Numbytes)
930 IF Byte=8 THEN OUTPUT @Comm USING "#,AAAAAAA";VAL$(Numbytes)
940 !
950 ! ***** SAVE BUFFER POINTERS *****
960 ! Save the transfer buffer pointer so it can be restored after the
970 ! transfer.
980 !
990 STATUS @Buff,5;Streg
1000 !
1010 ! ***** TRANSFER SETUP TO THE HP 16500B *****
1020 ! Transfer the setup from the buffer to the HP 16500B mainframe.
1030 !
1040 TRANSFER @Buff TO @Comm;COUNT Numbytes,WAIT
1050 !
1060 ! ***** RESTORE BUFFER POINTERS *****
1070 ! Restore the transfer buffer pointer
1080 !
1090 CONTROL @Buff,5;Streg
1100 !
1110 ! ***** SEND TERMINATING LINE FEED *****
1120 ! Send the terminating linefeed to properly terminate the setup string.
1130 !
1140 OUTPUT @Comm;" "
1150 !
1160 PRINT "**** SENT THE SETUP ****"
1170 END
```

Checking for Intermodule Measurement Completion

This program can be appended to or inserted into another program when you need to know when an intermodule measurement is complete. If it is at the end of a program it will tell you when measurement is complete. If you insert it into a program, it will halt the program until the current measurement is complete.

```
420 ! ***** CHECK FOR MEASUREMENT COMPLETE *****
430 ! Enable the MESR register and query the register for a measurement
440 ! complete condition.
450 !
460 OUTPUT 707;":SYSTEM:HEADER OFF"
470 OUTPUT 707;":SYSTEM:LONGFORM OFF"
480 !
490 Status=0
500 OUTPUT 707;":MESE0 1"
510 OUTPUT 707;":MESR0?"
520 ENTER 707;Status
530 !
540 ! Print the MESR register status.
550 !
560 CLEAR SCREEN
570 PRINT "Measurement complete status is ";Status
580 PRINT "0 = not complete, 1 = complete"
590 ! Repeat the MESR query until measurement is complete.
600 WAIT 1
610 IF Status=1 THEN GOTO 630
620 GOTO 510
630 PRINT TABXY(30,15);"Measurement is complete"
640 !
650 END
```

Sending Queries to the Logic Analysis System

This program example contains the steps required to send a query to the logic analysis system. Sending the query alone only puts the requested information in an output buffer of the logic analysis system. You must follow the query with an ENTER statement to transfer the query response to the controller. When the query response is sent to the logic analysis system, the query is properly terminated in the logic analyzer. If you send the query but fail to send an ENTER statement, the logic analysis system will display the error message "Query Interrupted" when it receives the next command from the controller, and, the query response is lost.

```

10  !***** QUERY EXAMPLE *****
19  !           for the HP 16500B/16501A Logic analysis system
30  !
40  ! ***** OPTIONAL *****
50  ! The following two lines turn the headers and longform on so
60  ! that the query name, in its long form, is included in the
70  ! query response.
80  !
90  !           ***** NOTE *****
100 !           If your query response includes real
110 !           or integer numbers that you may want
120 !           to do statistics or math on later, you
130 !           should turn both header and longform
140 !           off so only the number is returned.
150 !           *****
160 !
170 OUTPUT 707;":SYSTEM:HEADER ON"
180 OUTPUT 707;":SYSTEM:LONGFORM ON"
190 !
200 ! *****
210 ! Select the mainframe.
220 ! Always a 0 for the HP 16500B/16501A mainframe.
230 OUTPUT 707;":SELECT 0"
240 !
250 ! *****
260 ! Dimension a string in which the query response will be entered.
270 !
280 DIM Query$[100]
290 !
300 ! *****

```

Programming Examples
Sending Queries to the Logic Analysis System

```
310 ! Send the query. In this example the MENU? query is sent. All
320 ! queries except the SYSTEM:DATA and SYSTEM:SETup can be sent with
330 ! this program.
340 !
350 OUTPUT 707;"MENU?"
360 !
370 ! *****
380 ! The two lines that follow transfer the query response from the
390 ! query buffer to the controller and then print the response.
400 !
410 ENTER 707;Query$
420 PRINT Query$
430 !
440 !
450 END
```

Getting ASCII Data with PRINT? ALL Query

This program example shows you how to get ASCII data from a listing display, like the disk catalog or state listing, using the PRINT? ALL query. There are two things you must keep in mind:

- You must select the mainframe, which is always SELECT 0 for the HP 16500B mainframe.
- You must select the proper menu. The only menus that allow you to use the PRINT? ALL query are the disk menu and listing menus.

```
10      !                ***** ASCII DATA *****
20      !
30      !
40      ! This program gets the hard disk directory from the HP 16500B mainframe
50      ! in ASCII form by using the PRINT? ALL query.
60      !
70      !*****
80      !
90      DIM Block$(32000)
100     OUTPUT 707;"EOI ON"
110     OUTPUT 707;":SYSTEM:HEAD OFF"
120     OUTPUT 707;":SELECT 0" ! Always a 0 for the HP 16500B mainframe
130     !
140     !
150     OUTPUT 707;":MENU 0,1" ! Selects the hard disk menu. Print? All
160                               ! will only work in disk menu and listings.
170     !
180     OUTPUT 707;":SYSTEM:PRINT? ALL"
190     ENTER 707 USING "-K";Block$
200     !
210     !*****
220     ! Now display the ASCII data you received.
230     !
240     PRINT USING "K";Block$
250     !
260     END
```


Reading the disk with the CATALOG? ALL query

The following example program reads the catalog of the currently selected disk drive. The CATALOG? ALL query returns the entire 70-character field. Because DOS directory entries are 70 characters long, you should use the CATALOG? ALL query with DOS disks.

```
10      !                ***** DISK CATALOG *****
20      !                using the CATALOG? ALL query
30      !
40      DIM File$(100)
50      DIM Specifier$(2)
60      OUTPUT 707;":EOI ON"
70      OUTPUT 707;":SYSTEM:HEADER OFF"
80      OUTPUT 707;":MMEMORY:MSI INTERNAL0" ! select the hard drive
90      OUTPUT 707;":MMEMORY:CATALOG? ALL"  ! send CATALOG? ALL query
100     !
110     ENTER 707 USING "#,2A";Specifier$    ! read in #8
120     ENTER 707 USING "#,8D";Length       ! read in block length
130     !
140     ! Read and print each file in the directory
150     !
160     FOR I=1 TO Length STEP 70
170         ENTER 707 USING "#,70A";File$
180         PRINT File$
190     NEXT I
200     ENTER 707 USING "A";Specifier$      ! read in final line feed
210     END
```

Reading the Disk with the CAtalog? Query

This example program uses the CATALOG? query without the ALL option to read the catalog of the currently selected disk drive. However, if you do not use the ALL option, the query only returns a 51-character field. Keep in mind if you use this program with a DOS disk, each filename entry will be truncated at 51 characters.

```
10      !                ***** DISK CATALOG *****
20      !                using the CATALOG? query
30      !
40      DIM File$(100)
50      DIM Specifier$(2)
60      OUTPUT 707;":EOI ON"
70      OUTPUT 707;":SYSTEM:HEADER OFF"
80      OUTPUT 707;":MMEMORY:MSI INTERNAL0" ! select the hard drive
90      OUTPUT 707;":MMEMORY:CATALOG?"      ! send CATALOG? query
100     !
110     ENTER 707 USING "#,2A";Specifier$    ! read in #8
120     ENTER 707 USING "#,8D";Length        ! read in block length
130     !
140     ! Read and print each file in the directory
150     !
160     FOR I=1 TO Length STEP 51
170         ENTER 707 USING "#,51A";File$
180         PRINT File$
190     NEXT I
200     ENTER 707 USING "A";Specifier$      ! read in final line feed
210     END
```

Printing to the disk

This program prints acquired data to a disk file. The file can be either on a LIF or DOS disk. If you print the file to a flexible disk in the DOS format, you will be able to view the file on a DOS compatible computer using any number of file utility programs.

```
10      !          ***** PRINTING TO A DISK FILE *****
20      !
30      !
40      ! This program prints the acquired data to a disk file on a floppy disk.
50      ! It will print to either a LIF or DOS file using the PRINT ALL command.
60      !
70      !*****
80      ! This program assumes a logic analyzer module
85      ! is installed in slot 1.
90      OUTPUT 707;":SELECT 1"  ! Selects the module in slot 1. This program
100     ! assumes a logic analyzer module is installed
110     ! in slot 1.
115     !
120     OUTPUT 707;":MENU 1,7"  ! Selects the Listing 1 menu.  Print to disk
130     ! will only work in Listing and Disk menus.
140     !
150     OUTPUT 707;":SYSTEM:PRINT ALL, DISK, 'DISKFILE', INTERNAL1"
160     !
170     !*****
180     ! Now display catalog to see that the file has been saved on the disk.
190     !
200     DIM File$(100)
210     DIM Specifier$(2)
220     OUTPUT 707;":EOI ON"
230     OUTPUT 707;":SYSTEM:HEADER OFF"
235     OUTPUT 707;":MMEMORY:MSI INTERNAL1"
240     OUTPUT 707;":MMEMORY:CATALOG? ALL"
250     ENTER 707 USING "#,2A";Specifier$
260     ENTER 707 USING "#,8D";Length
270     FOR I=1 TO Length STEP 70
280         ENTER 707 USING "#,70A";File$
290         PRINT File$
300     NEXT I
310     ENTER 707 USING "A";Specifier$
320     END
```

!

- *CLS command, 8-5
- *ESE command, 8-6
- *ESR command, 8-7
- *IDN command, 8-9
- *IST command, 8-9
- *OPC command, 8-11
- *OPT command, 8-12
- *PRE command, 8-13
- *RST command, 8-14
- *SRE command, 8-15
- *STB command, 8-16
- *TRG command, 8-17
- *TST command, 8-18
- *WAI command, 8-19
- ..., 4-5
- 32767, 4-4
- 9.9E+37, 4-4
- ::=, 4-5
- , 4-6
- [], 4-5
- { }, 4-5
- |, 4-5

A

- Addressed talk/listen mode, 2-3
- Angular brackets, 4-5
- Arguments, 1-8
- AUToload command, 11-8

B

- Bases, 1-13
- BASIC, 1-3
- Baud rate, 3-10
- BEEPer command, 9-6
- Bit definitions, 6-4 to 6-5
- Block data, 1-7, 1-21
- Block length specifier, 10-5, 10-12
- Braces, 4-5
- bus addressing
 - HP-IB, 2-4

C

- Cable
 - RS-232C, 3-3
- CAPability command, 9-7
- Card identification numbers, 9-8
- CARDcage command, 9-8
- CATalog command, 11-9

- CD command, 11-10
- CESE command, 9-10
- CESR command, 9-11
- Clear To Send (CTS), 3-5
- clock
 - real-time, 9-20
- CME, 6-5
- Combining commands, 1-10
- Comma, 1-13
- Command, 1-7, 1-17
 - *CLS, 8-5
 - *ESE, 8-6
 - *OPC, 8-11
 - *PRE, 8-13
 - *RST, 8-14
 - *SRE, 8-15
 - *TRG, 8-17
 - *WAI, 8-19
- AUToload, 11-8
- BEEPer, 9-6
- CD (change directory), 11-10
- CESE, 9-10
- COPY, 11-11
- DATA, 10-5
- DELeTe, 12-5
- DOWNload, 11-12
- DSP, 10-6
- EOI, 9-13
- HEADer, 1-17, 10-8
- INITialize, 11-14
- INPort, 12-7
- INSert, 12-8
- LOAD:CONFig, 11-15
- LOAD:IASSEMBler, 11-16
- LOCKout, 3-12, 9-14
- LONGform, 1-17, 10-9
- MENU, 9-15
- MESE, 9-16
- MKDir, 11-17
- MSI, 11-18
- PACK, 11-19
- PRINT, 10-10
- PURGe, 11-20
- REName, 11-22
- RMODE, 9-19
- RTC, 9-20
- SELeCt, 9-21
- SETColor, 9-23
- SETup, 10-12

- SKEW, 12-11
- START, 9-24
- STOP, 9-25
- STORE:CONFig, 11-23
- SYStem:DATA, 10-5
- SYStem:SETup, 10-12
- TREE, 12-12
- XWINDow, 9-26
- Command errors, 7-3
- Command mode, 2-3
- Command set organization, 4-9
- Command structure, 1-5
- Command tree, 4-6
 - SELeCt, 9-22
- Command types, 4-6
- Common commands, 1-10, 4-6, 8-2
- Communication, 1-3
- Compound commands, 1-9
- Configuration file, 1-4
- Controller mode, 2-3
- Controllers, 1-3
- Conventions, 4-5
- COPY command, 11-11

D

- DATA, 10-5
 - command, 10-5
- Data bits, 3-10
 - 8-Bit mode, 3-10
- Data Carrier Detect (DCD), 3-5
- DATA command/query, 10-5
- Data Communications Equipment, 3-3
- Data mode, 2-3
- Data Set Ready (DSR), 3-5
- Data Terminal Equipment, 3-3
- Data Terminal Ready (DTR), 3-5
- DCE, 3-3
- DCL, 2-6
- DDE, 6-5
- Definite-length block response data, 1-21
- DELeTe command, 12-5
- Device address, 1-7
 - HP-IB, 2-4
 - RS-232C, 3-11
- Device clear, 2-6
- Device dependent errors, 7-3
- Documentation conventions, 4-5

DOWNload command, 11-12
DSP command, 10-6
DTE, 3-3
Duplicate keywords, 1-10

E

Ellipsis, 4-5
Embedded strings, 1-3, 1-7
Enter statement, 1-3
EOI command, 9-13
ERRor command, 10-7
Error messages, 7-2
ESB, 6-4
Event Status Register, 6-4
Examples
 program, 13-2
EXE, 6-5
Execution errors, 7-4
Exponents, 1-13
Extended interface, 3-5

F

File types, 11-13
Fractional values, 1-14

G

GET, 2-6
Group execute trigger, 2-6

H

HEADER command, 1-17, 10-8
Headers, 1-7, 1-9, 1-12
Host language, 1-7
HP 16500L LAN Interface Module, 1-3, iii-iii
HP-IB, 2-2 to 2-3, 6-8
HP-IB address, 2-4
HP-IB commands, 6-13
HP-IB device address, 2-4
HP-IB interface, 2-3
HP-IB interface code, 2-4
HP-IB interface functions, 2-2
HTIME query, 12-6

I

IEEE 488.1, 2-2, 5-2
IEEE 488.1 bus commands, 2-6
IEEE 488.2, 5-2
IFC, 2-6
Infinity, 4-4
Initialization, 1-4
INITialize command, 11-14
INPort command, 12-7
Input buffer, 5-3
INSert command, 12-8
Instruction headers, 1-7
Instruction parameters, 1-8
Instruction syntax, 1-6
Instruction terminator, 1-8
Instructions, 1-6
Instrument address, 2-4
Interface capabilities, 2-3
 RS-232C, 3-10
Interface clear, 2-6
Interface code
 HP-IB, 2-4
Interface select code
 RS-232C, 3-11
INTermodule subsystem, 12-2
Internal errors, 7-4

K

Keyword data, 1-14
Keywords, 4-3

L

LAN programming, 1-3, iii-iii
LCL, 6-6
LER command, 9-13
Linefeed, 1-8, 4-6
LOAD:CONFIg command, 11-15
LOAD:IASSEmbler command, 11-16
Local, 2-5
Local lockout, 2-5
LOCKout command, 3-12, 9-14
Longform, 1-12
LONGform command, 1-17, 10-9
Lowercase, 1-12

M

Mainframe commands, 9-2
MAV, 6-4
measurement complete program example, 13-6
MENU command, 9-15
MESE command, 9-16
MESR command, 9-18
MKDir command, 11-17
MMEMory subsystem, 11-2
Mnemonics, 1-14, 4-3
MSB, 6-6
MSG, 6-5
MSI command, 11-18
MSS, 6-4
Msus, 11-3
Multiple numeric variables, 1-22
Multiple program commands, 1-15
Multiple queries, 1-22
Multiple subsystems, 1-15

N

New Line character, 1-8
NL, 1-8, 4-6
Notation conventions, 4-5
Numeric base, 1-20
Numeric bases, 1-13
Numeric data, 1-13
Numeric variables, 1-20

O

OPC, 6-6
Operation Complete, 6-6
OR notation, 4-5
Output buffer, 1-11
Output queue, 5-3
OUTPUT statement, 1-3
Overlapped command, 8-11, 8-19, 9-24 to 9-25
Overlapped commands, 4-4

P

PACK command, 11-19
Parallel poll, 6-9
Parallel poll commands, 6-14
Parameter syntax rules, 1-13
Parameters, 1-8
Parity, 3-10

-
- Parse tree, 5-8
 Parser, 5-3
 PON, 6-5
 PPC, 6-13
 PPD, 6-14
 PPE, 6-14
 PPU, 6-13
 PRINT command, 10-10
 Printer mode, 2-3
 program example
 checking for measurement complete, 13-6
 getting ASCII data with PRINT ALL query, 13-9
 sending queries to the mainframe, 13-7
 SYSTEM:SETup command, 13-3
 SYSTEM:SETup? query, 13-3
 transferring configuration to analyzer, 13-3
 transferring configuration to the controller, 13-3
 Program examples, 4-12, 13-2
 Program message syntax, 1-6
 Program message terminator, 1-8
 Program syntax, 1-6
 Programming
 over the LAN, 1-3, iii-iii
 Programming conventions, 4-5
 Protocol, 3-10, 5-4
 None, 3-10
 XON/XOFF, 3-10
 Protocol exceptions, 5-5
 Protocols, 5-3
 PURGe command, 11-20
- Q**
- Query, 1-7, 1-11, 1-17
 *ESE, 8-6
 *ESR, 8-7
 *IDN, 8-9
 *IST, 8-9
 *OPC, 8-11
 *OPT, 8-12
 *PRE, 8-13
 *SRE, 8-15
 *STB, 8-16
 *TST, 8-18
 AUToload, 11-8
 BEEPPer, 9-6
 CAPability, 9-7
- CARDcage, 9-8
 CATalog, 11-9
 CESE, 9-10
 CESR, 9-11
 DATA, 10-6
 EOI, 9-13
 ERRor, 10-7
 FTIME, 12-6
 HEADer, 10-8
 INPort, 12-7
 LER, 9-13
 LOCKout, 9-14
 LONGform, 10-9
 MENU, 9-16
 MESE, 9-17
 MESR, 9-18
 MSI, 11-18
 PRINT, 10-11
 RMODE, 9-19
 SElect, 9-21
 SETColor, 9-24
 SETup, 10-12
 SKEW, 12-11
 SYSTEM:DATA, 10-6
 SYSTEM:SETup, 10-12
 TREE, 12-13
 TTIME, 12-13
 UPLoad, 11-24
 Query errors, 7-5
 query program example, 13-7
 Query responses, 1-16, 4-4
 Question mark, 1-11
 QYE, 6-5
- R**
- real-time clock, 9-20
 Receive Data (RD), 3-4 to 3-5
 Remote, 2-5
 Remote enable, 2-5
 REN, 2-5
 REName command, 11-22
 Request To Send (RTS), 3-5
 Response data, 1-21
 Responses, 1-17
 RMODE command, 9-19
 Root, 4-8
- RQC, 6-5
 RQS, 6-5
 RS-232C, 3-2, 3-11, 5-2
 RTC (real-time clock), 9-20
- S**
- SDC, 2-6
 SElect command, 9-21
 Select command tree, 9-22
 Selected device clear, 2-6
 Sequential commands, 4-4
 Serial poll, 6-8
 Service Request Enable Register, 6-4
 SETColor command, 9-23
 SETup, 10-12
 SETup command/query, 10-12 to 10-13
 Shortform, 1-12
 Simple commands, 1-9
 SKEW command, 12-11
 Spaces, 1-8
 Square brackets, 4-5
 STARt command, 9-24
 Status, 1-23, 6-2, 8-3
 Status byte, 6-6
 Status registers, 1-23, 8-3
 Status reporting, 6-2
 Stop bits, 3-10
 STOP command, 9-25
 STORe:CONFIg command, 11-23
 String data, 1-14
 String variables, 1-19
 Subsystem
 INTermodule, 12-2
 MMEMory, 11-2
 SYSTEM, 10-2
 Subsystem commands, 4-6
 Suffix multiplier, 5-9
 Suffix units, 5-10
 Syntax diagram
 Common commands, 8-4
 INTermodule subsystem, 12-3
 Mainframe commands, 9-3 to 9-4
 MMEMory subsystem, 11-4 to 11-5, 11-7
 SYSTEM subsystem, 10-3
 Syntax diagrams
 IEEE 488.2, 5-5
 System commands, 4-6
 system modules
-

talking to, 1-4
SYSTem subsystem, 10-2
SYSTem:SETup command program
example, 13-3
SYSTem:SETup query program example,
13-3

T

Talk only mode, 2-3
Terminator, 1-8
Three-wire Interface, 3-4
Trailing dots, 4-5
Transmit Data (TD), 3-4 to 3-5
TREE command, 12-12
Truncation rule, 4-3
TTIME query, 12-13

U

Units, 1-13
UPLoad command, 11-24
Uppercase, 1-12
URQ, 6-5

W

White space, 1-8

X

XWINDow command, 9-26
XXX, 4-5, 4-8
XXX (meaning of), 1-7

© Copyright Hewlett-Packard Company 1987, 1990, 1993, 1994
All Rights Reserved.

Reproduction, adaptation, or translation without prior written permission is prohibited, except as allowed under the copyright laws.

Document Warranty

The information contained in this document is subject to change without notice.

Hewlett-Packard makes no warranty of any kind with regard to this material, including, but not limited to, the implied warranties of merchantability or fitness for a particular purpose.

Hewlett-Packard shall not be liable for errors contained herein or for damages in connection with the furnishing, performance, or use of this material.

Safety

This apparatus has been designed and tested in accordance with IEC Publication 348, Safety Requirements for Measuring Apparatus, and has been supplied in a safe condition. This is a Safety Class I instrument (provided with terminal for protective earthing). Before applying power, verify that the correct safety precautions are taken (see the following warnings). In addition, note the external markings on the instrument that are described under "Safety Symbols."

Warning

- Before turning on the instrument, you must connect the protective earth terminal of the instrument to the protective conductor of the (mains) power cord. The mains plug shall only be inserted in a socket outlet provided with a protective earth contact. You must not negate the protective action by using an extension cord (power cable) without a protective conductor (grounding). Grounding one conductor of a two-conductor outlet is not sufficient protection.
- Only fuses with the required rated current, voltage, and specified type (normal blow, time delay, etc.) should be used. Do not use repaired fuses or short-circuited fuseholders. To do so could cause a shock or fire hazard.

- Service instructions are for trained service personnel. To avoid dangerous electric shock, do not perform any service unless qualified to do so. Do not attempt internal service or adjustment unless another person, capable of rendering first aid and resuscitation, is present.

- If you energize this instrument by an auto transformer (for voltage reduction), make sure the common terminal is connected to the earth terminal of the power source.

- Whenever it is likely that the ground protection is impaired, you must make the instrument inoperative and secure it against any unintended operation.

- Do not operate the instrument in the presence of flammable gasses or fumes. Operation of any electrical instrument in such an environment constitutes a definite safety hazard.

- Do not install substitute parts or perform any unauthorized modification to the instrument.

- Capacitors inside the instrument may retain a charge even if the instrument is disconnected from its source of supply.

- Use caution when exposing or handling the CRT. Handling or replacing the CRT shall be done only by qualified maintenance personnel.

Safety Symbols



Instruction manual symbol: the product is marked with this symbol when it is necessary for you to refer to the instruction manual in order to protect against damage to the product.



Hazardous voltage symbol.



Earth terminal symbol: Used to indicate a circuit common connected to grounded chassis.

WARNING

The Warning sign denotes a hazard. It calls attention to a procedure, practice, or the like, which, if not correctly performed or adhered to, could result in personal injury. Do not proceed beyond a Warning sign until the indicated conditions are fully understood and met.

CAUTION

The Caution sign denotes a hazard. It calls attention to an operating procedure, practice, or the like, which, if not correctly performed or adhered to, could result in damage to or destruction of part or all of the product. Do not proceed beyond a Caution symbol until the indicated conditions are fully understood or met.

Product Warranty

This Hewlett-Packard product has a warranty against defects in material and workmanship for a period of one year from date of shipment. During the warranty period, Hewlett-Packard Company will, at its option, either repair or replace products that prove to be defective.

For warranty service or repair, this product must be returned to a service facility designated by Hewlett-Packard.

For products returned to Hewlett-Packard for warranty service, the Buyer shall prepay shipping charges to Hewlett-Packard and Hewlett-Packard shall pay shipping charges to return the product to the Buyer. However, the Buyer shall pay all shipping charges, duties, and taxes for products returned to Hewlett-Packard from another country.

Hewlett-Packard warrants that its software and firmware designated by Hewlett-Packard for use with an instrument will execute its programming instructions when properly installed on that instrument.

Hewlett-Packard does not warrant that the operation of the instrument software, or firmware will be uninterrupted or error free.

Limitation of Warranty

The foregoing warranty shall not apply to defects resulting from improper or inadequate maintenance by the Buyer, Buyer-supplied software or interfacing, unauthorized modification or misuse, operation outside of the environmental specifications for the product, or improper site preparation or maintenance.

No other warranty is expressed or implied. Hewlett-Packard specifically disclaims the implied warranties of merchantability or fitness for a particular purpose.

Exclusive Remedies

The remedies provided herein are the buyer's sole and exclusive remedies. Hewlett-Packard shall not be liable for any direct, indirect, special, incidental, or consequential damages, whether based on contract, tort, or any other legal theory.

Assistance

Product maintenance agreements and other customer assistance agreements are available for Hewlett-Packard products.

For any assistance, contact your nearest Hewlett-Packard Sales Office.

Certification

Hewlett-Packard Company certifies that this product met its published specifications at the time of shipment from the factory. Hewlett-Packard further certifies that its calibration measurements are traceable to the United States National Institute of Standards and Technology, to the extent allowed by the Institute's calibration facility, and to the calibration facilities of other International Standards Organization members.

About this edition

This is the first edition of the *HP 16500B/16501A Programmer's Guide*.

Publication number
16500-97009

Printed in USA.

Edition dates are as follows:
Second edition, April 1994

New editions are complete revisions of the manual. Update packages, which are issued between editions, contain additional and replacement pages to be merged into the manual by you. The dates on the title page change only when a new edition is published.

A software or firmware code may be printed before the date. This code indicates the version level of the software or firmware of this product at the time the manual or update was issued. Many product updates do not require manual changes; and, conversely, manual corrections may be done without accompanying product changes. Therefore, do not expect a one-to-one correspondence between product updates and manual updates.

The following list of pages gives the date of the current edition and of any changed pages to that edition.

All pages original edition